

MANUAL TÉCNICO DE MONTAGEM



INSTRUÇÕES E INDICAÇÕES AO USUÁRIO

RESUMO:

OBRIGADO POR ADQUIRIR UM DE NOSSOS PRODUTOS. ESTE ITEM É UM PRODUTO COMERCIALIZADO PARA FINS ARTESANAIS, FABRICADO ATRAVES DO PROCESSO DE CORTE A LASER. A MADEIRA UTILIZADO NESTE SET É O MDF DE PINUS, MADEIRA DE REFLORESTAMENTO.

MONTAGEM:

PARA MONTAGEM DO PRODUTO, PEDIMOS AO USUÁRIO QUE DESTAQUE AS PEÇAS DO SET CONFORME UTILIZAÇÃO NUMÉRICA INDICADA NO MANUAL.

AS PEÇAS DEVEM ENCAIXAR-SE SUAVEMENTE NAS CAVIDADES, SUPORTES, OU ESPAÇOS DESTINADOS AS MESMAS.

CASO HAJA CERTA DIFICULDADE DE ENCAIXE, FRICÇÃO, OU REBARBA DE FILAMENTOS DA CARTELA, RECOMENDAMOS A REMOÇÃO DO EXESSO DE SUPERFÍCIE DAS MESMAS, COM O AUXÍLIO DE UM ESTILETE OU UMA FACA. NÃO QUEBRE AS PEÇAS.

CASO NAO TENHA EXPERIENCIA COM MONTAGENS, INDICAMOS A FIXAÇÃO PRIMÁRIA DAS PEÇAS

CASA DE BONECAS MODELO MIRIAN V.5

COM O AUXÍLIO DE FITA CREPE, APLICANDO-SE POSTERIORMENTE COLA NA JUNÇÃO DAS PEÇAS INDICADAS.

SIMBOLOGIA

LEGENDA



Atenção: verifique a correta posição do objeto. Geralmente este tipo de peça não pode ser montado/colado do lado inverso.



Procedimento de medição: verifique o tamanho conforme especificado. Caso necessário, utilize a régua guia para efetuar os cortes necessários. Utilizado para as varetas.

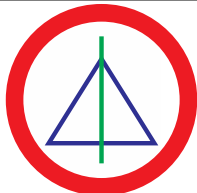

Simetria: Manter os dois lados com o mesmo tamanho/distância ou centralizar.



Procedimento de corte: Realize corte ou aparar rebarbas das partes. Utilizado para acabamentos.



Não colar: Peças ou eixos móveis são somente encaixados ou posicionados. Caso haja colagem, poderá comprometer o funcionamento do mecanismo.



Lubrificação: Necessário aplicar algum tipo de lubrificante para diminuir o atrito entre as partes. Indicamos friccionar sobre uma vela as partes criando uma camada superficial de parafina.



Peças de Reposição: Em alguns casos pode ser que haja algumas peças ou conjuntos de reposição disponível no kit.



Procedimento de lixação: Em alguns casos pode ser que haja necessidade de desbastar a superfície da peça com o auxílio de uma lixa de granulação média; ou utilizar uma lixa de unha.

MATERIAIS NECESSÁRIOS PARA MONTAGEM

ALGUMAS FERRAMENTAS PODEM SER NECESSÁRIAS PARA FACILITAR O PROCESSO DE MONTAGEM DO QUEBRA CABEÇAS. VAMOS DESCREVER ALGUMAS DELAS ABAIXO:



Estilete/faca: estilete de uso artesanal ou uma faca para cortes e arremates de peças.



Tesoura: Para acabamentos e cortes de peças.



Lixa: Para desbaste e acabamento. Granulação variável, podendo ser utilizado também palitos de lixas ao invés de folhas.



Cola Instantânea: Em alguns pontos do projeto é necessário colar as partes. Pode-se utilizar cola instantânea ou cola para madeira. Indicamos as instantâneas por conta da rapidez no processo de colagem. Observar se a cola é indicada para uso em madeira.



Alicate de corte reto: Alicate de corte utilizado para recorte das varetas e de outras partes. Indicamos um alicate de corte reto para minimizar o uso da lixa no desbaste, podendo ser substituído por um cortador ou alicate de unha de boa qualidade.

INÍCIO DA MONTAGEM:

1A

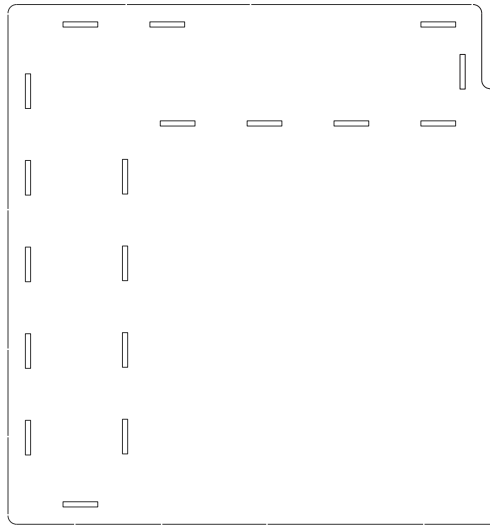

1B

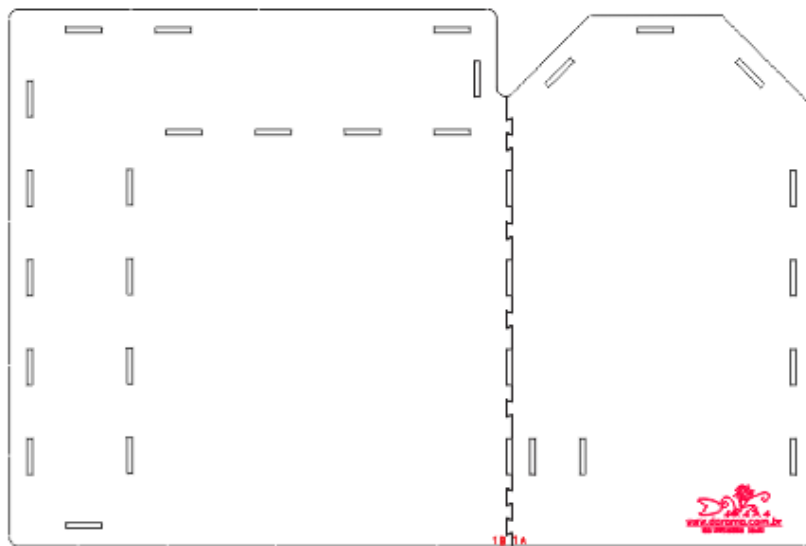
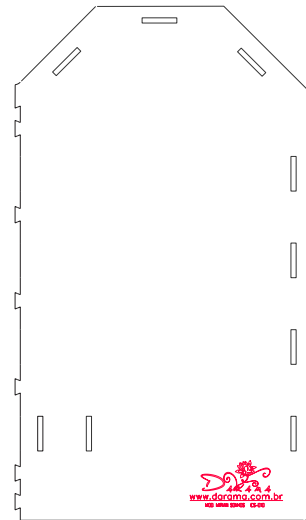

CASA DE BONECAS MODELO MIRIAN V.5

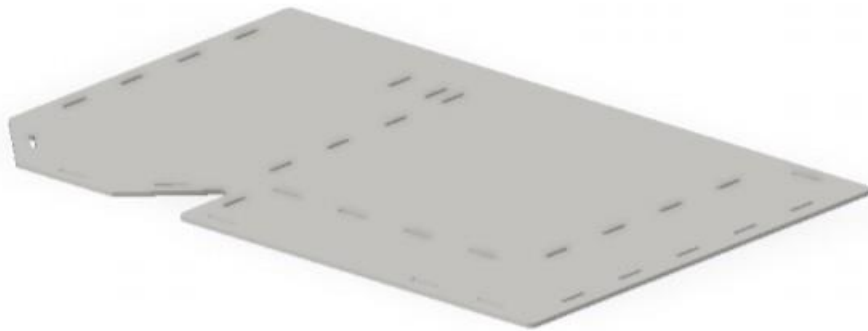
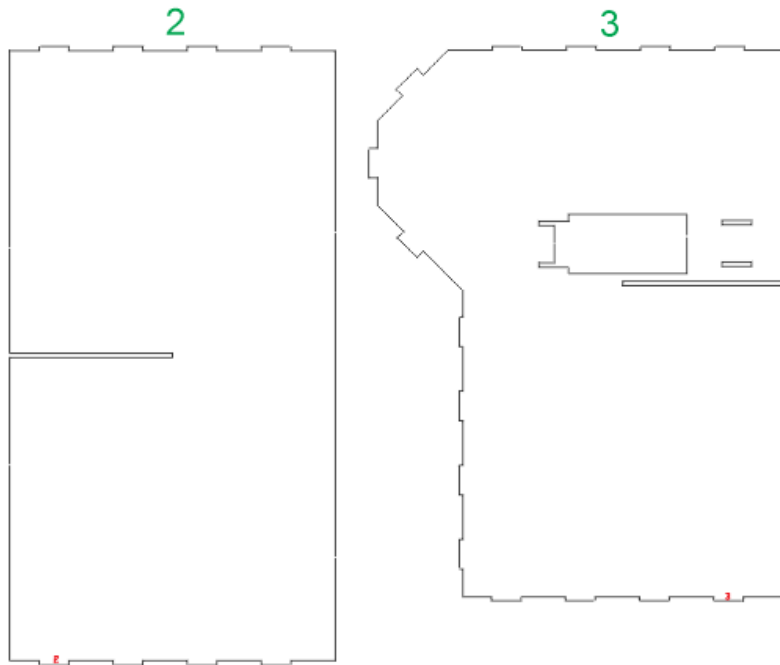

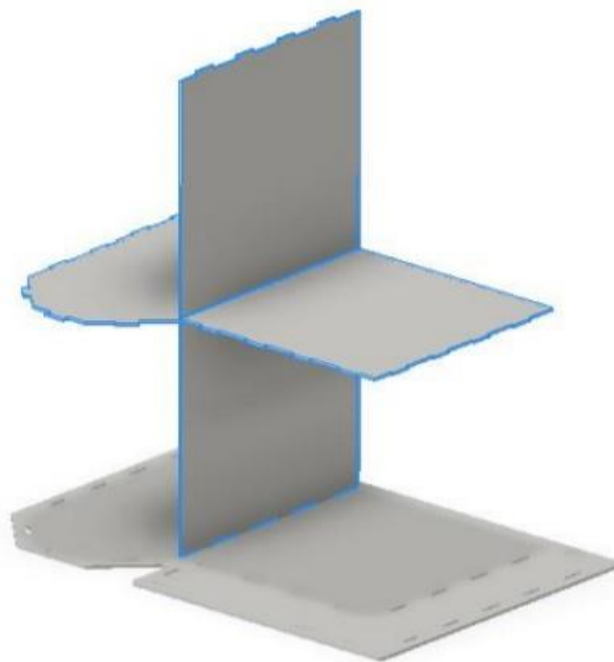
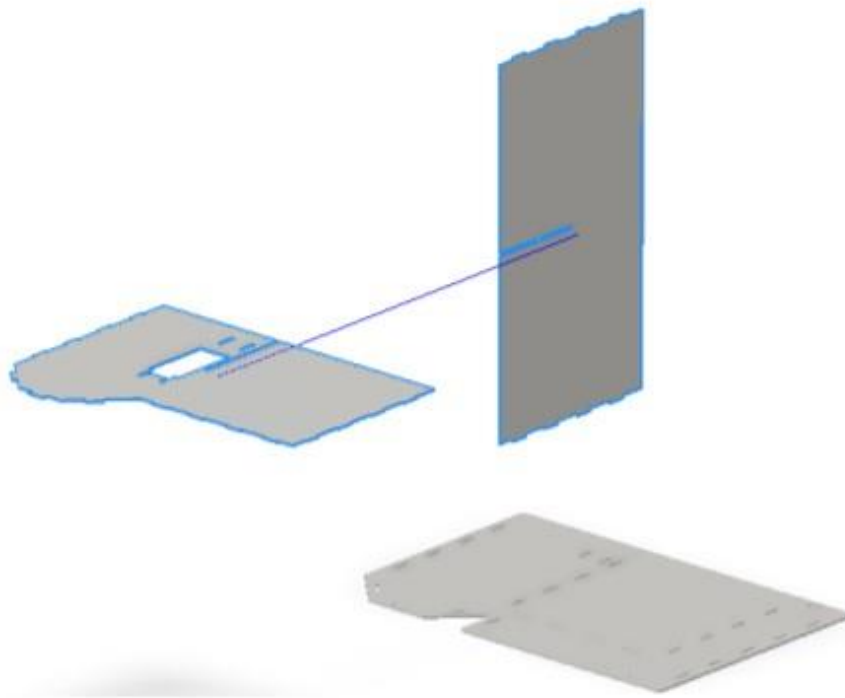

CASA DE BONECAS MODELO MIRIAN V.5

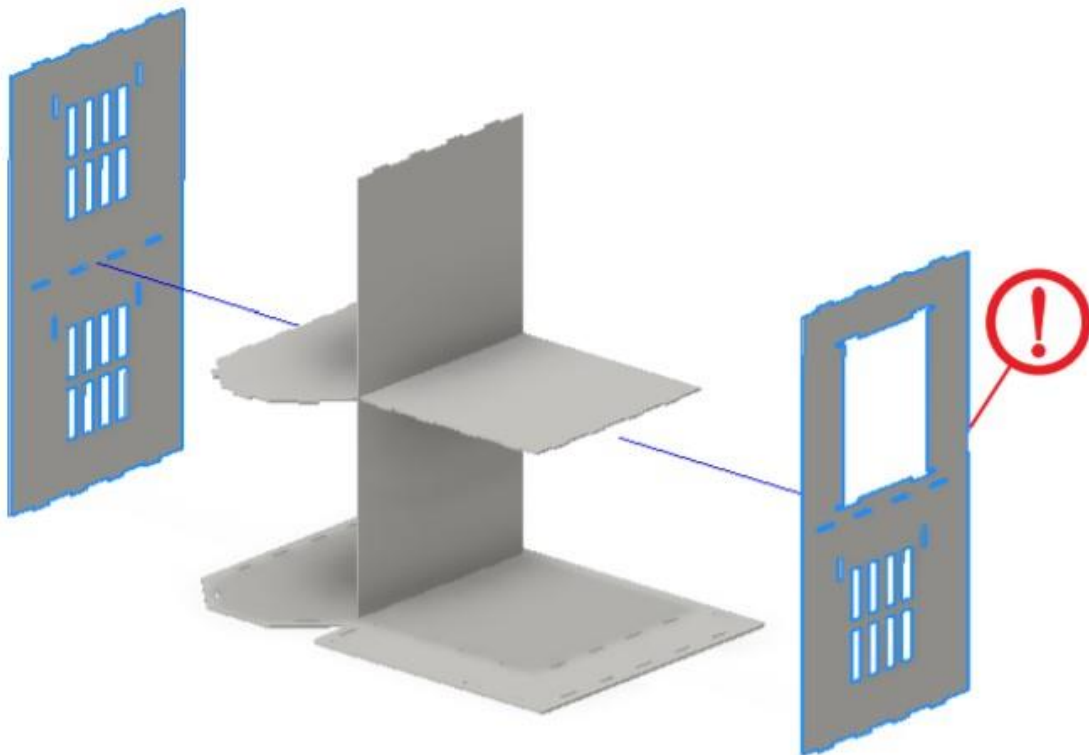
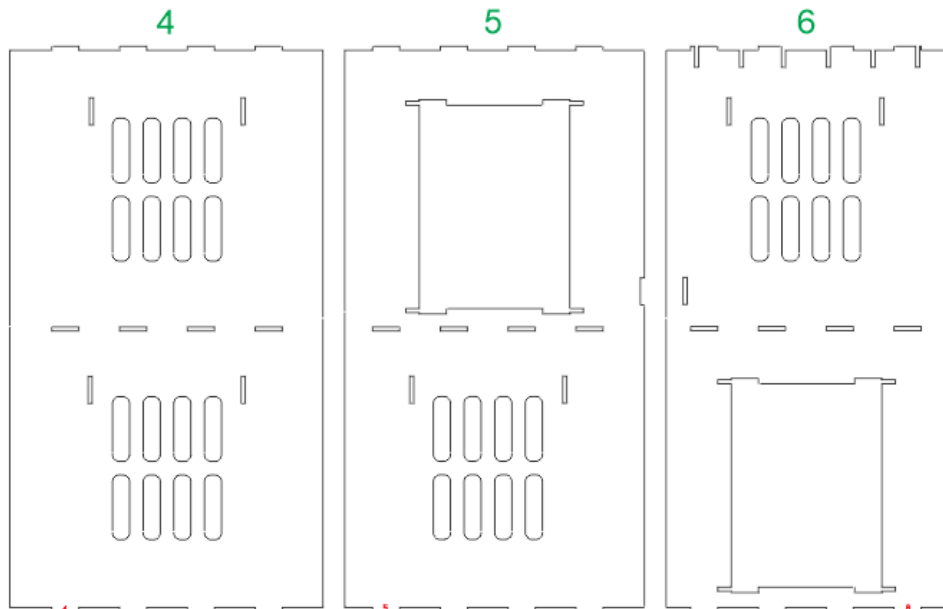

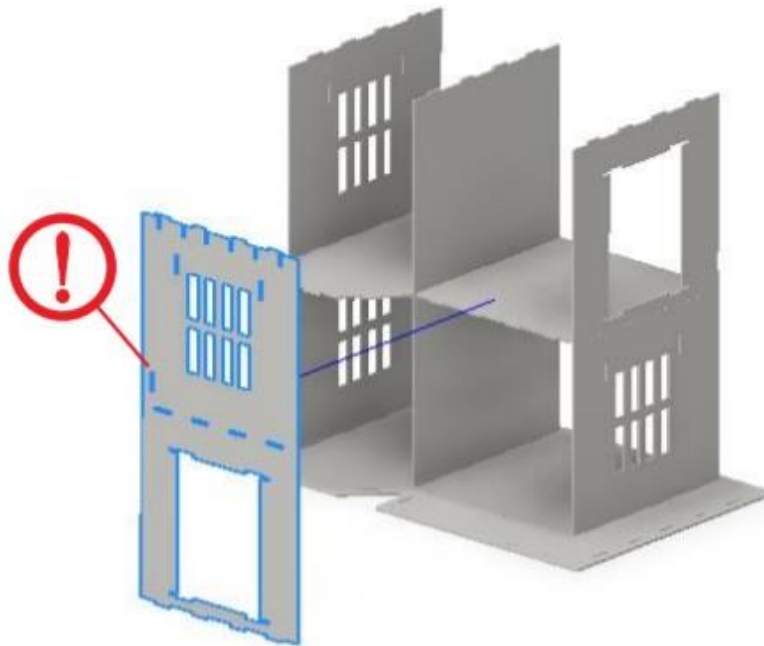
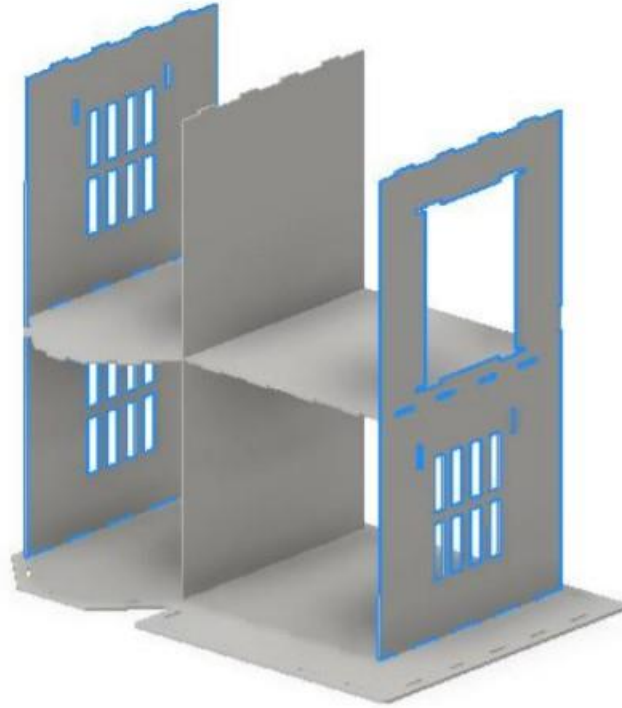

CASA DE BONECAS MODELO MIRIAN V.5

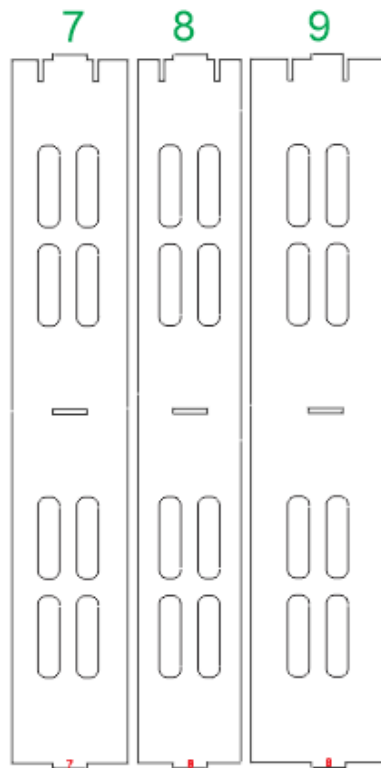
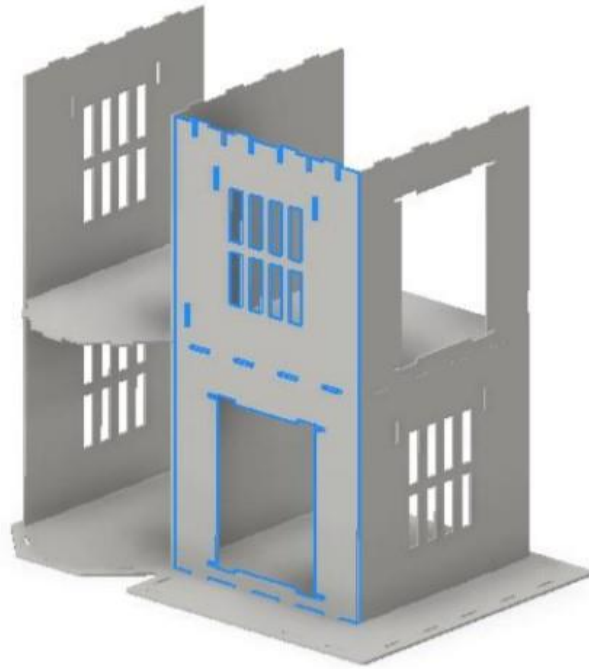

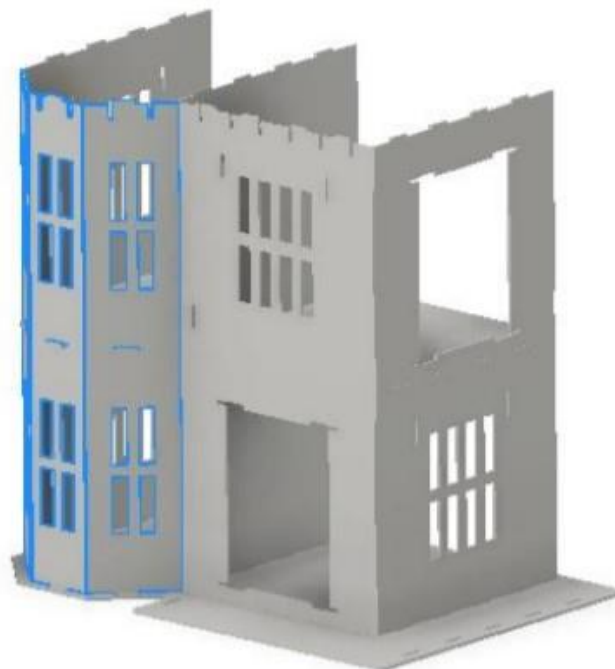
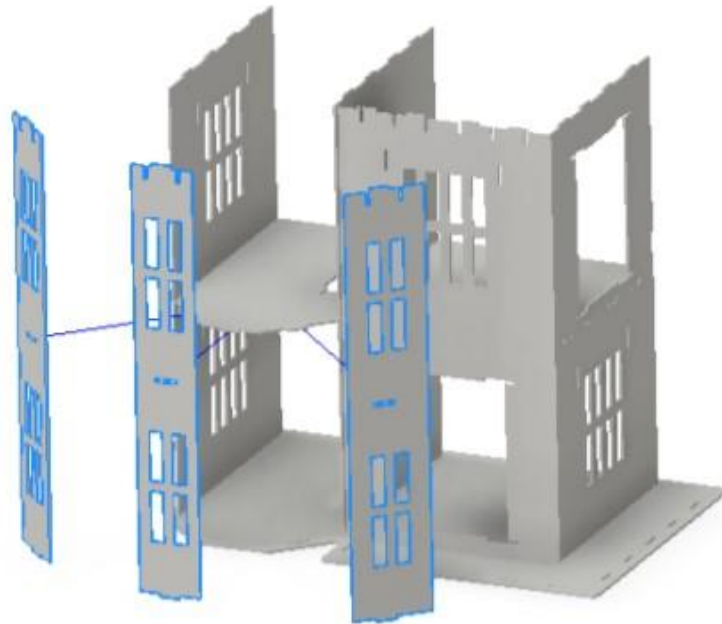

CASA DE BONECAS MODELO MIRIAN V.5

10

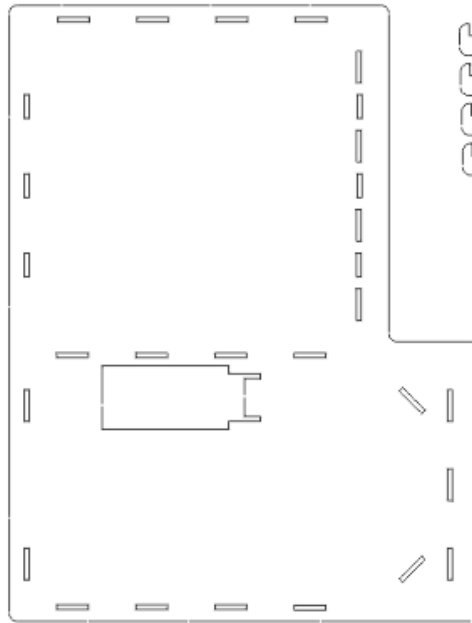

11

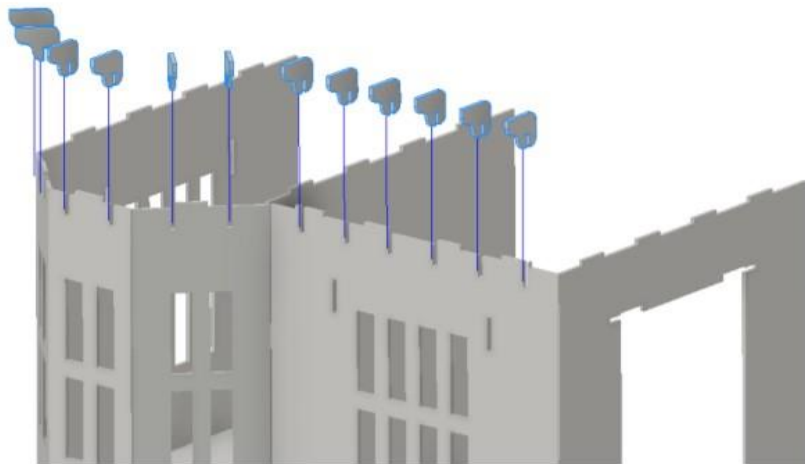

CASA DE BONECAS MODELO MIRIAN V.5

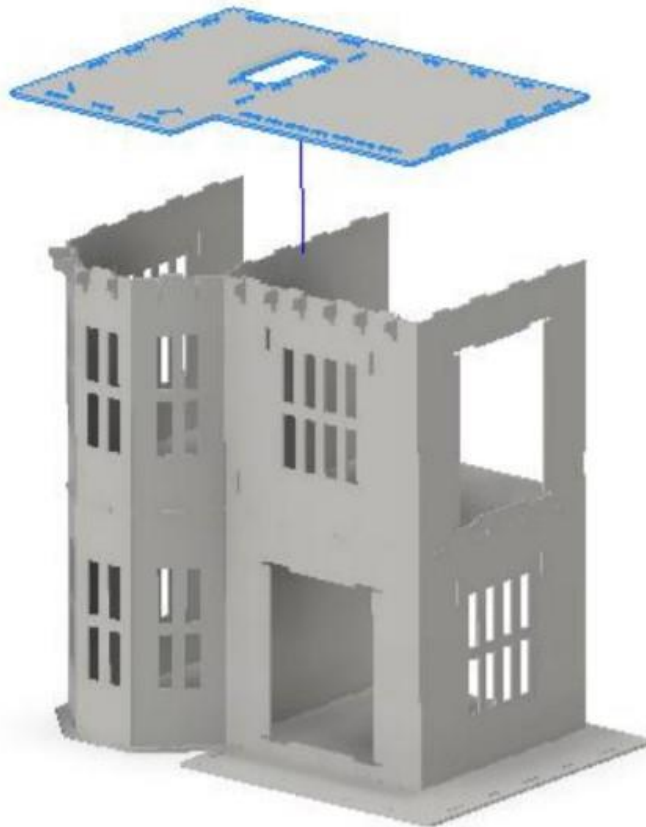
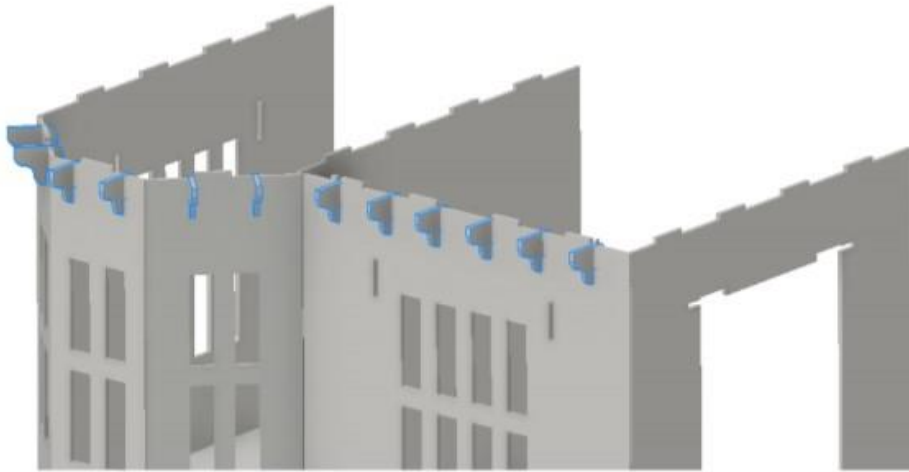

CASA DE BONECAS MODELO MIRIAN V.5



12

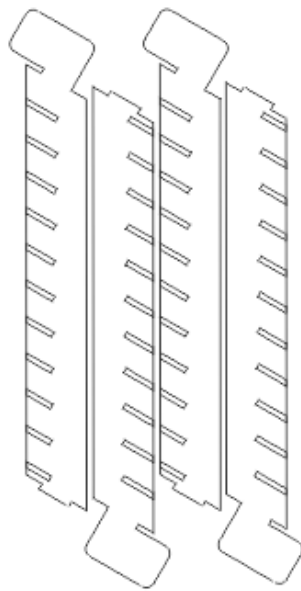

13

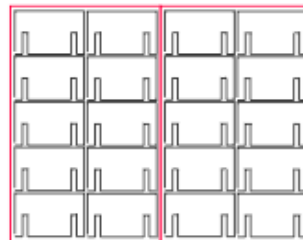

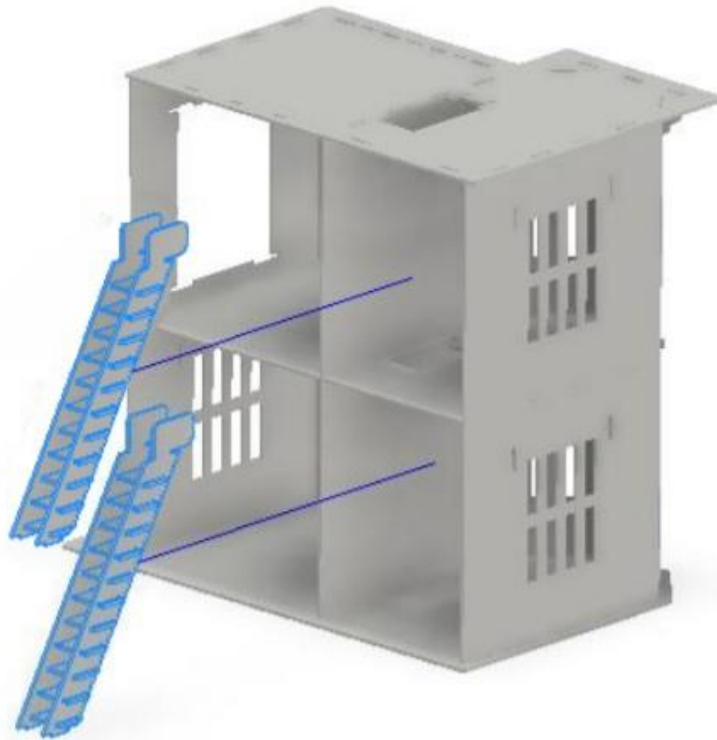

14 15 16

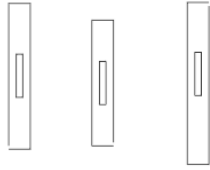

17

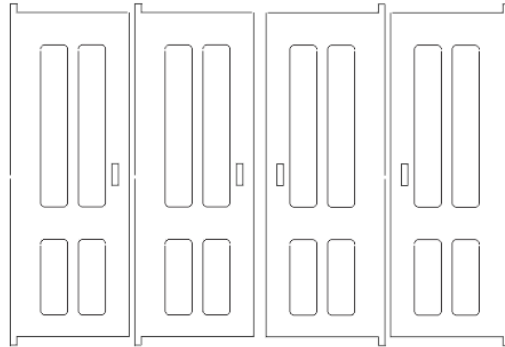

18 19

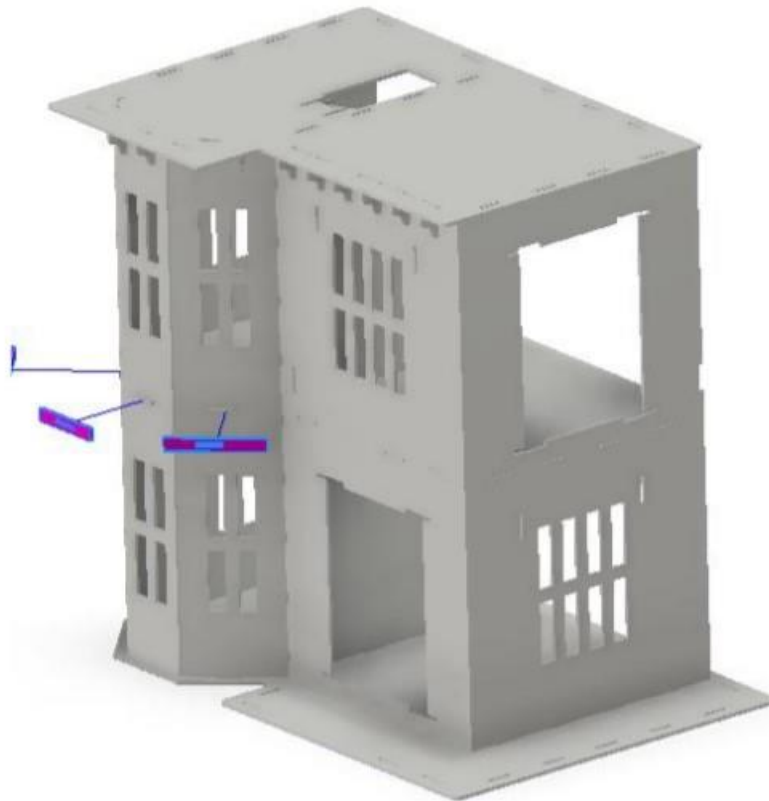
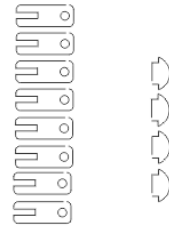

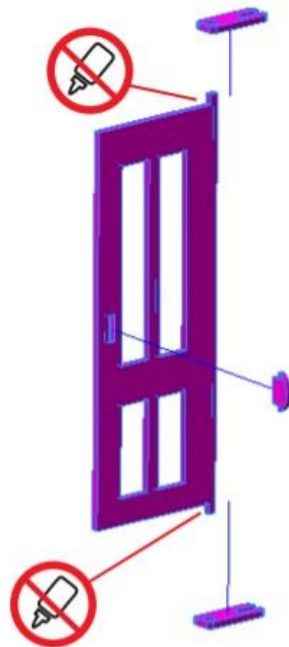

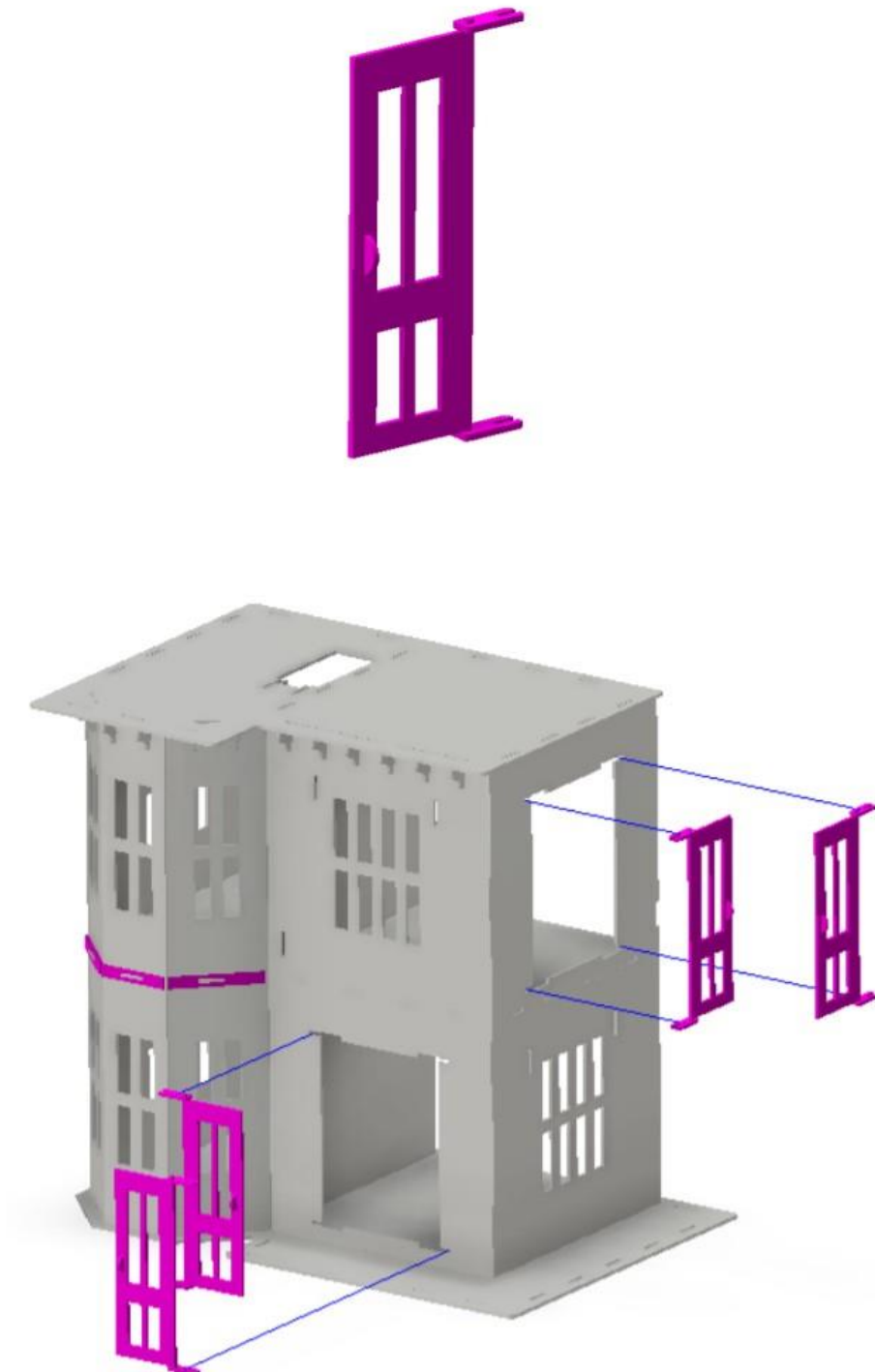

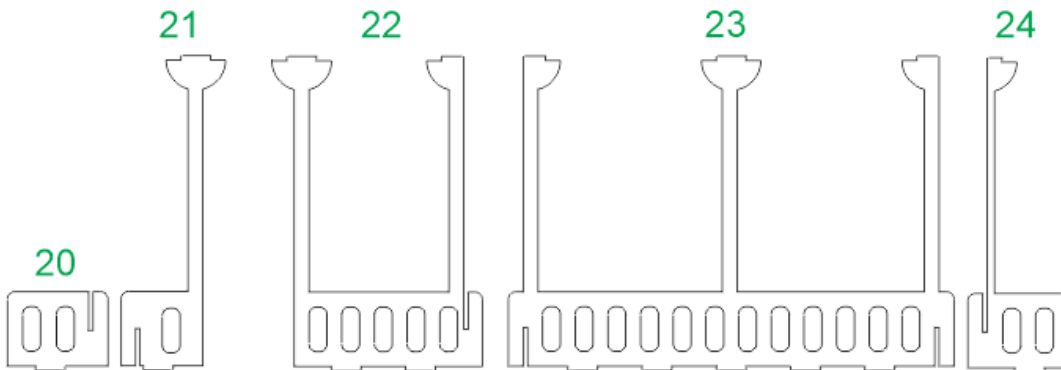

CASA DE BONECAS MODELO MIRIAN V.5

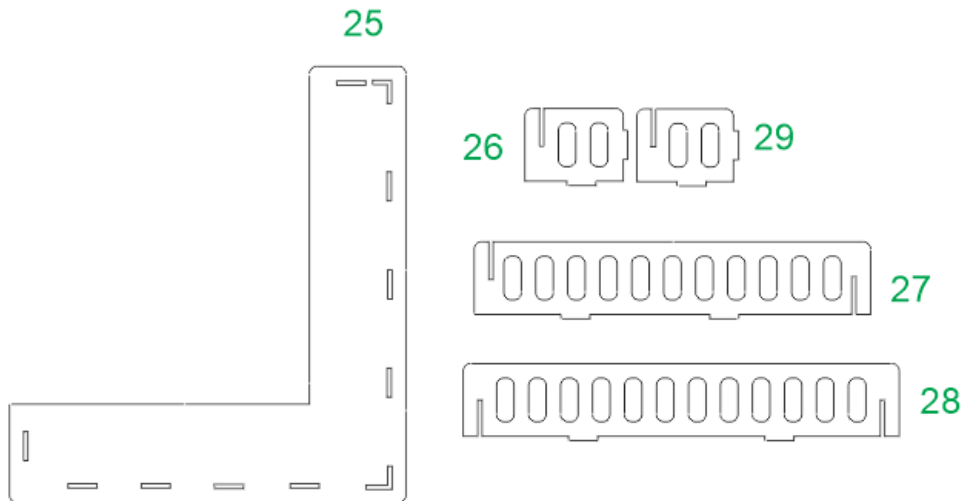
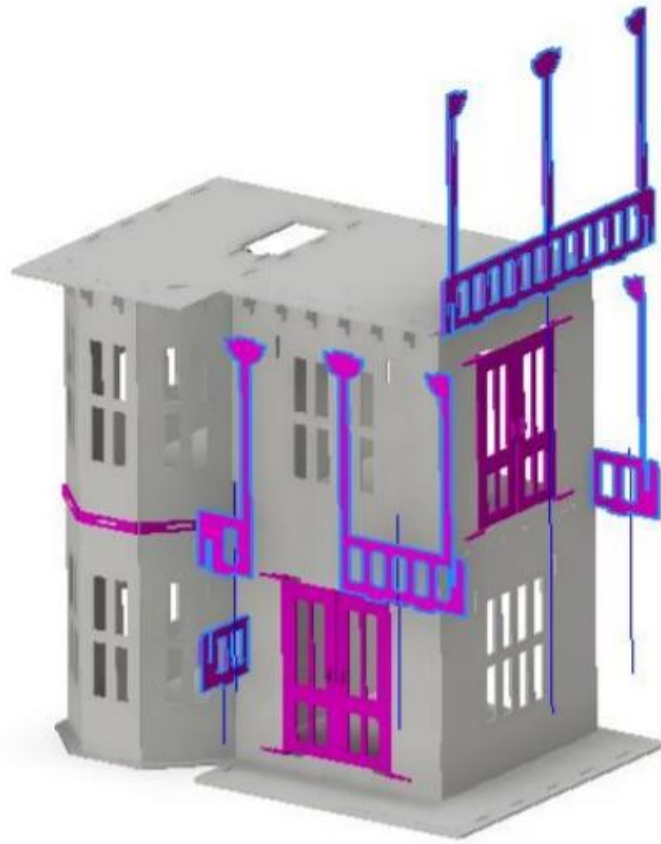

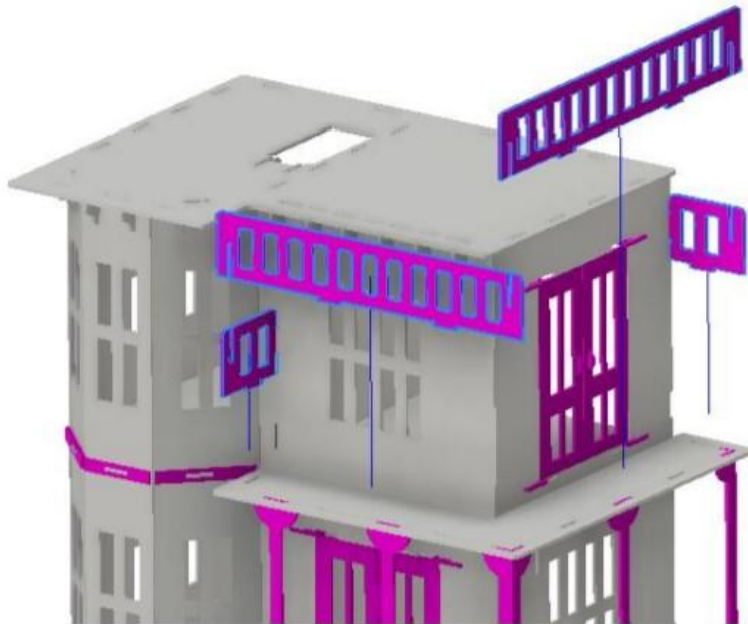
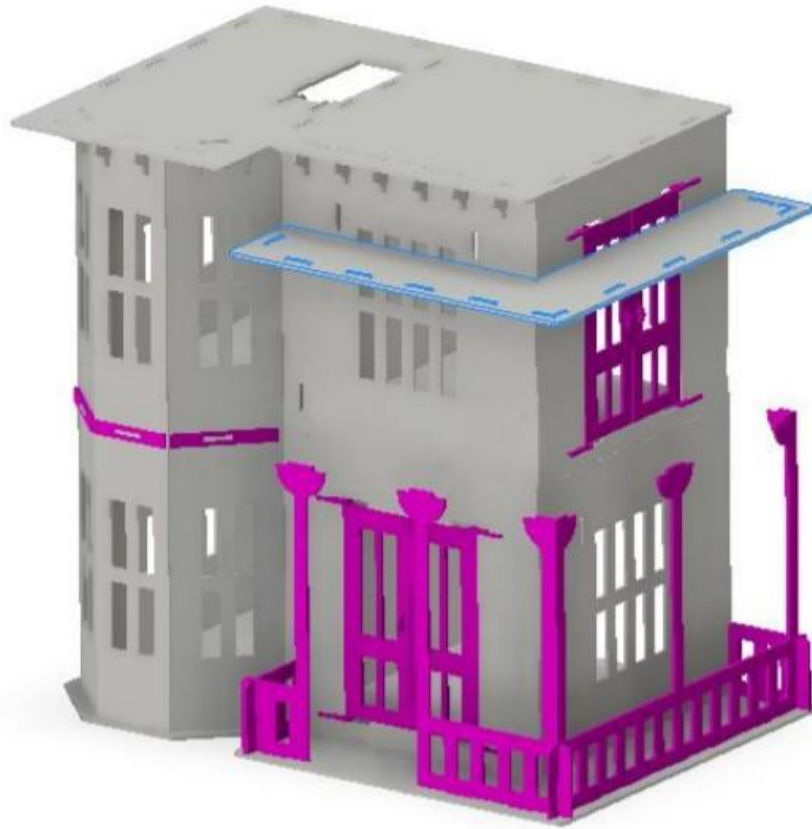

CASA DE BONECAS MODELO MIRIAN V.5

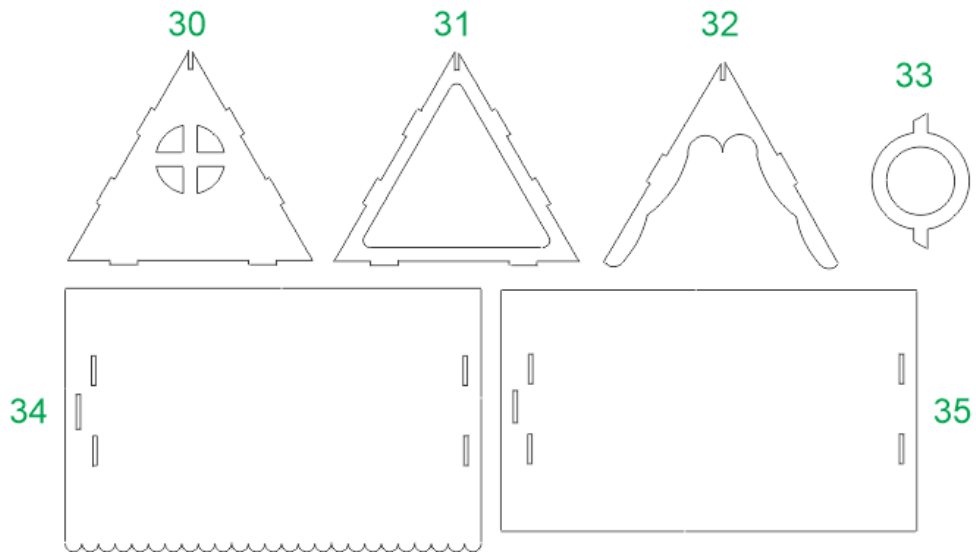

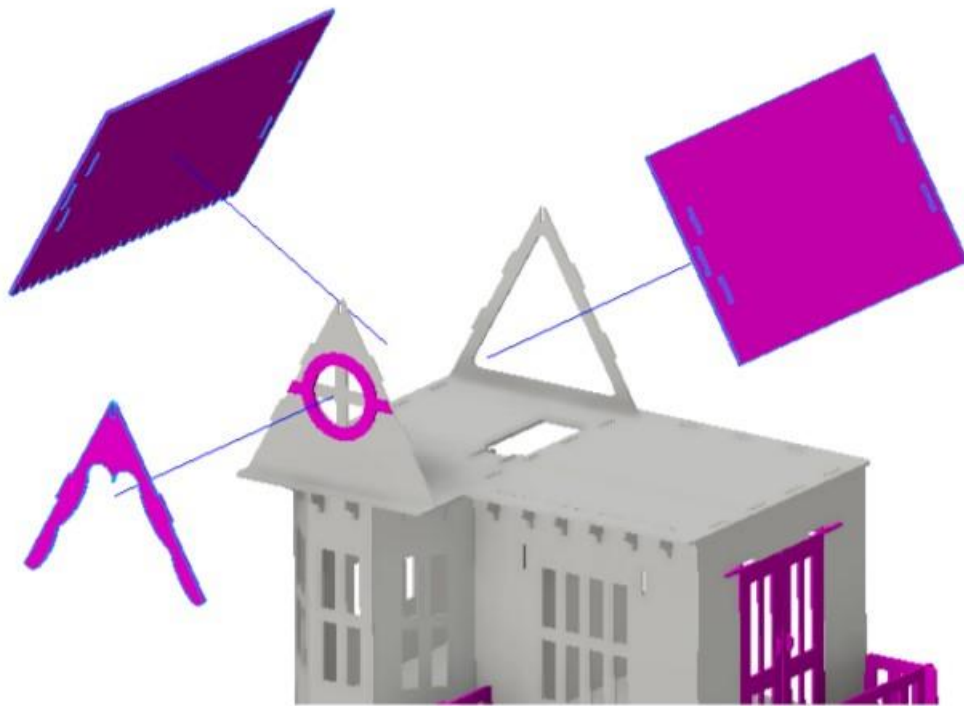
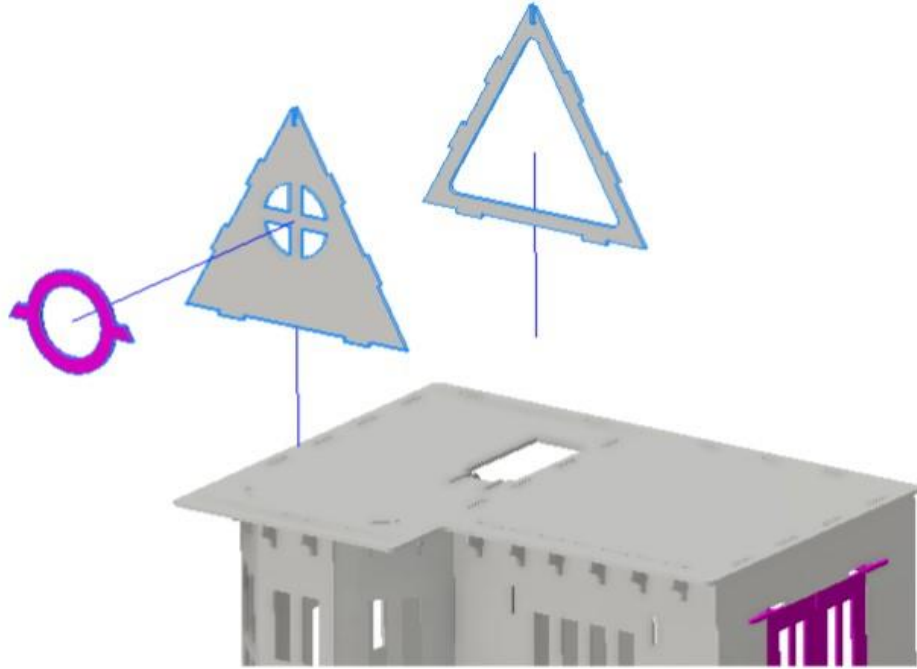

CASA DE BONECAS MODELO MIRIAN V.5

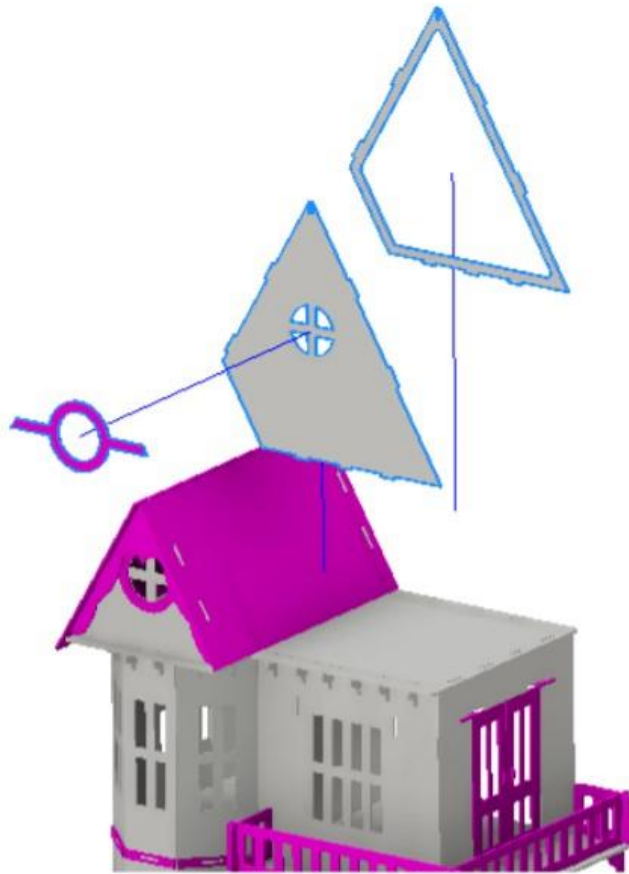
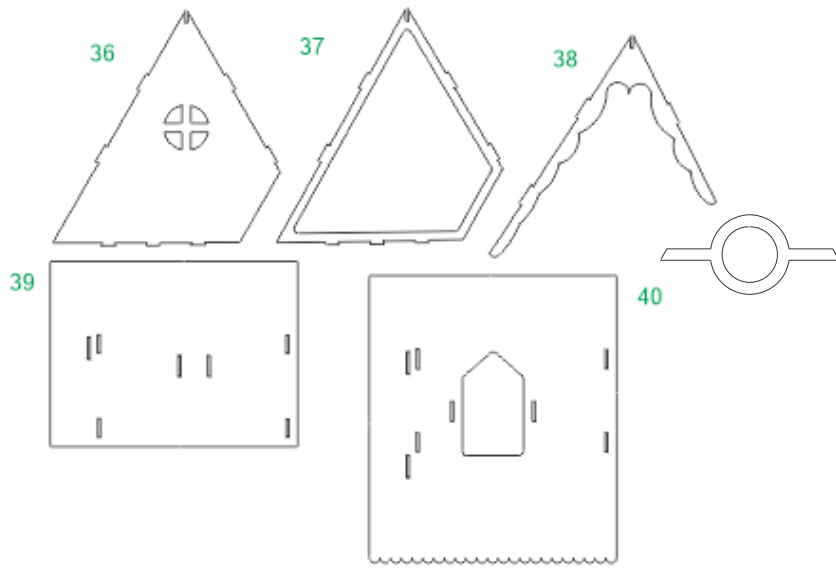

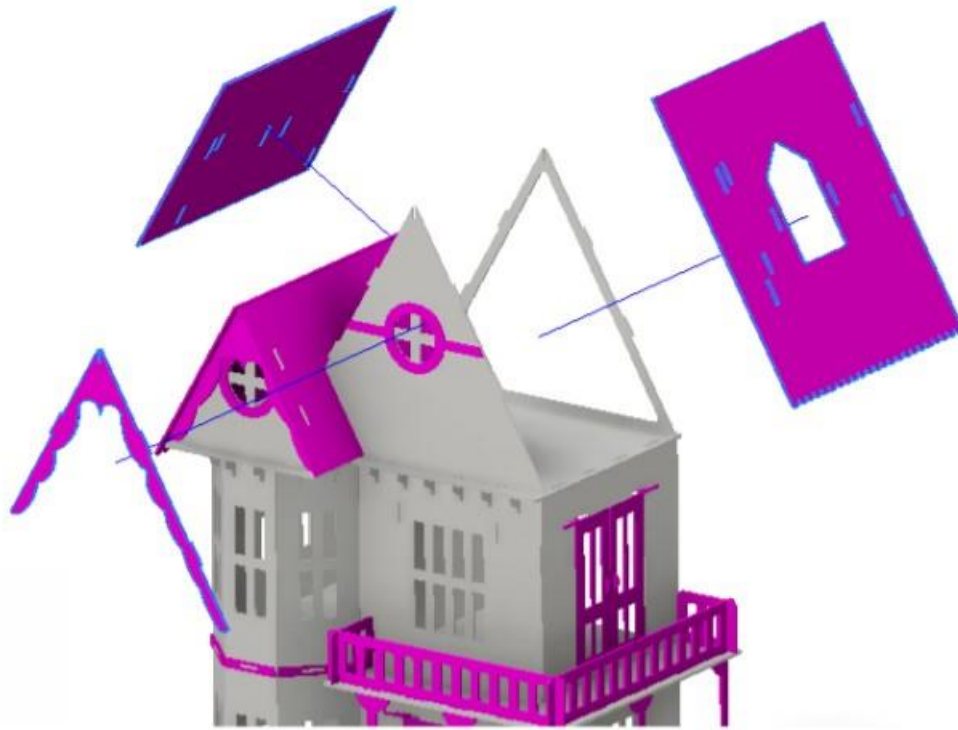

41

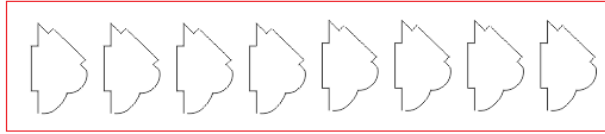

42

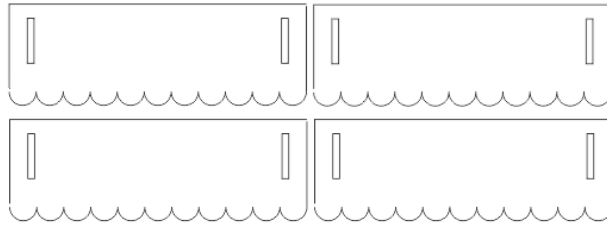



CASA DE BONECAS MODELO MIRIAN V.5

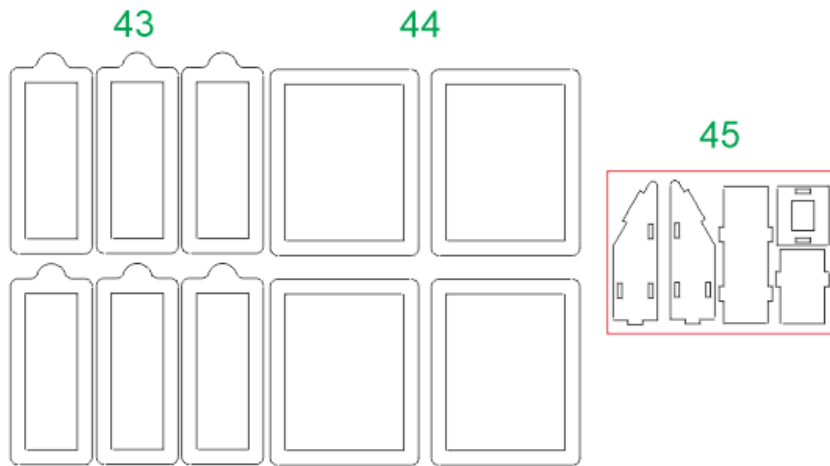



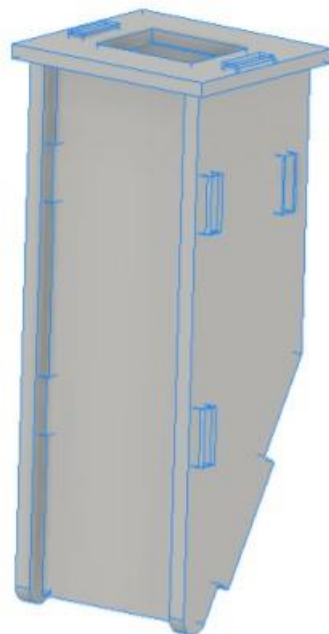
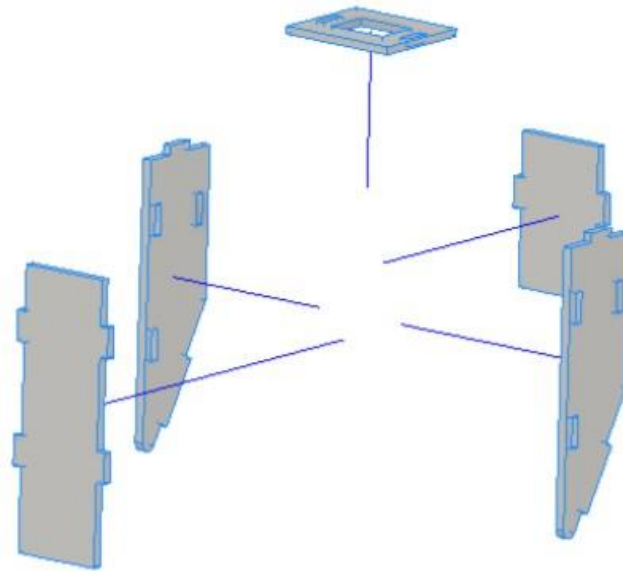



CASA DE BONECAS MODELO MIRIAN V.5

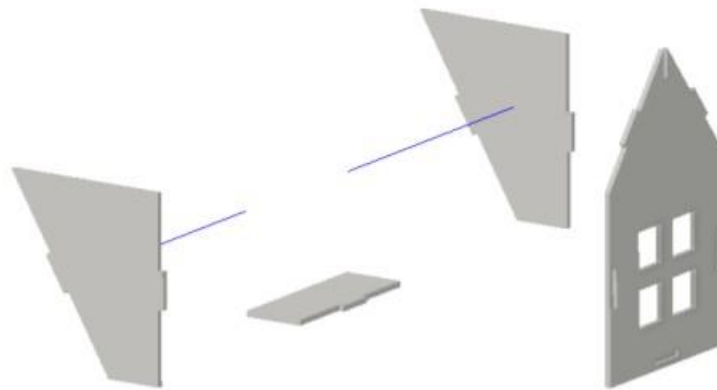
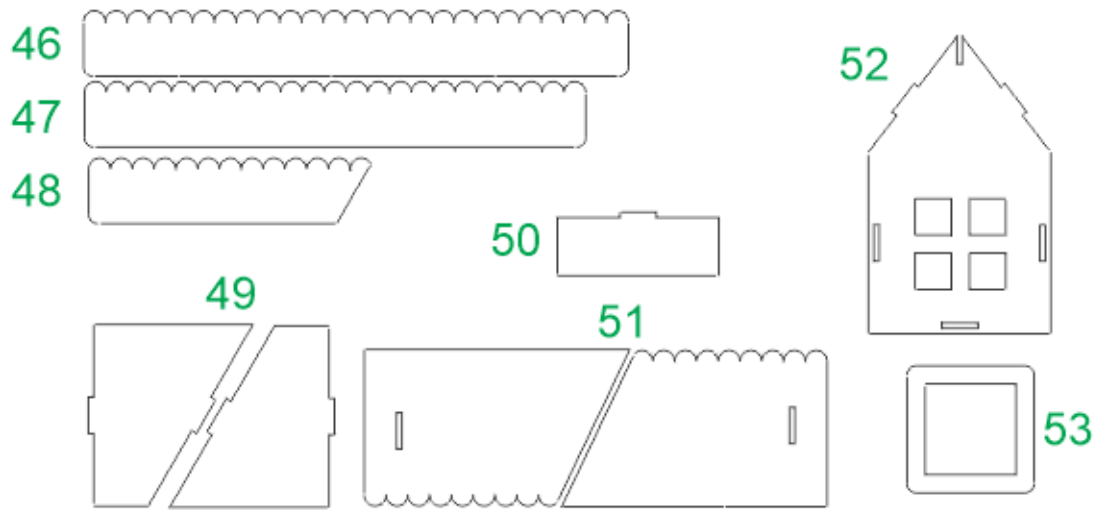

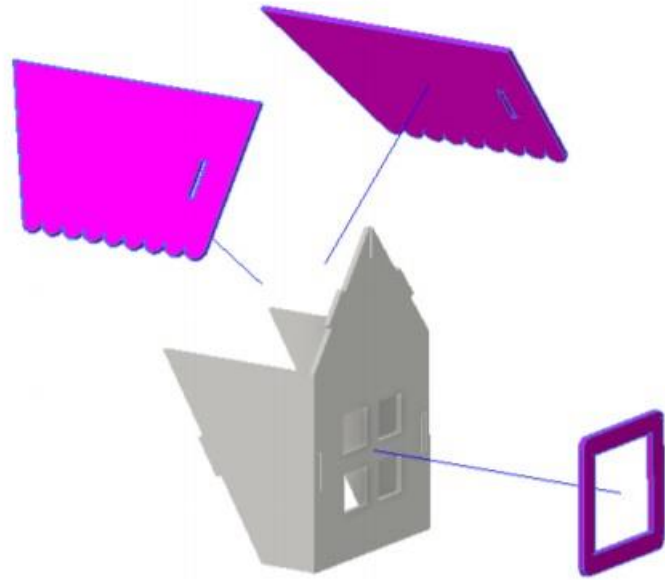



FIM.