

## MANUAL TÉCNICO DE MONTAGEM



## INSTRUÇÕES E INDICAÇÕES AO USUÁRIO

### RESUMO:

OBRIGADO POR ADQUIRIR UM DE NOSSOS PRODUTOS. ESTE ITEM É UM PRODUTO COMERCIALIZADO PARA FINS ARTESANAIS, FABRICADO ATRAVES DO PROCESSO DE CORTE A LASER. A MADEIRA UTILIZADO NESTE SET É O MDF DE 3MM DE PINUS, MADEIRA DE REFLORESTAMENTO.

### MONTAGEM:

PARA MONTAGEM DO PRODUTO, PEDIMOS AO USUÁRIO QUE DESTAQUE AS PEÇAS DO SET CONFORME UTILIZAÇÃO NUMÉRICA INDICADA NO MANUAL.

AS PEÇAS DEVEM ENCAIXAR-SE SUAVEMENTE NAS CAVIDADES, SUPORTES, OU ESPAÇOS DESTINADOS AS MESMAS.

CASO HAJA CERTA DIFICULDADE DE ENCAIXE, FRICÇÃO, OU REBARBA DE FILAMENTOS DA CARTELA, RECOMENDAMOS A REMOÇÃO DO EXESSO DE SUPERFÍCIE DAS MESMAS, COM O AUXÍLIO DE UM ESTILETE OU UMA FACA. NÃO QUEBRE AS PEÇAS.

CASO NAO TENHA EXPERIENCIA COM MONTAGENS, INDICAMOS A FIXAÇÃO PRIMÁRIA DAS PEÇAS COM O AUXÍLIO DE FITA CREPE, APLICANDO-SE POSTERIORMENTE COLA NA JUNÇÃO DAS PEÇAS INDICADAS.

**SIMBOLOGIA**

**LEGENDA**

---



**Atenção:** verifique a correta posição do objeto. Geralmente este tipo de peça não pode ser montada/colada do lado inverso.



**Procedimento de medição:** verifique o tamanho conforme especificado. Caso necessário, utilize a régua guia para efetuar os cortes necessários. Utilizado para as varetas.

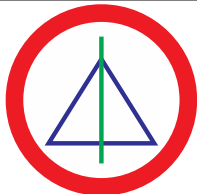

**Simetria:** Manter os dois lados com o mesmo tamanho/distância ou centralizar.



**Procedimento de corte:** Realize corte ou aparar rebarbas das partes. Utilizado para elásticos.



**Não colar:** Peças ou eixos móveis são somente encaixados ou posicionados. Caso haja colagem, poderá comprometer o funcionamento do mecanismo.



**Lubrificação:** Necessário aplicar algum tipo de lubrificante para diminuir o atrito entre as partes. Indicamos friccionar sobre uma vela as partes criando uma camada superficial de parafina.



**Peças de Reposição:** Em alguns casos pode ser que haja algumas peças ou conjuntos de reposição disponível no kit.

---



**Procedimento de lixção:** Em alguns casos pode ser que haja necessidade de desbastar a superfície da peça com o auxílio de uma lixa de granulação média; ou utilizar uma lixa de unha.

### MATERIAIS NECESSÁRIOS PARA MONTAGEM

ALGUMAS FERRAMENTAS PODEM SER NECESSÁRIAS PARA FACILITAR O PROCESSO DE MONTAGEM DO QUEBRA CABEÇAS. VAMOS DESCREVER ALGUMAS DELAS ABAIXO:



**Estilete/faca:** estilete de uso artesanal ou uma faca para cortes e arremates de peças.



**Tesoura:** Para acabamentos e cortes de peças.



**Lixa:** Para desbaste e acabamento. Granulação variável, podendo ser utilizado também palitos de lixas ao invés de folhas.



**Cola Instantânea:** Em alguns pontos do projeto é necessário colar as partes. Pode-se utilizar cola instantânea ou cola para madeira. Indicamos as instantâneas por conta da rapidez no processo de colagem. Observar se a cola é indicada para uso em madeira.



**Alicate de corte reto:** Alicate de corte utilizado para recorte das varetas e de outras partes. Indicamos um alicate de corte reto para minimizar o uso da lixa no desbaste, podendo ser substituído por um cortador ou alicate de unha de boa qualidade.

**MONTAGEM:**

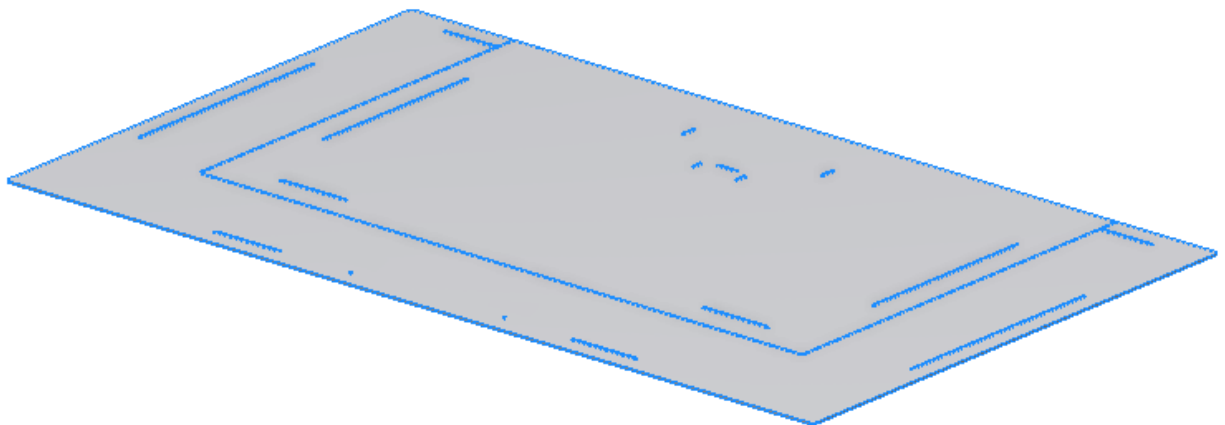
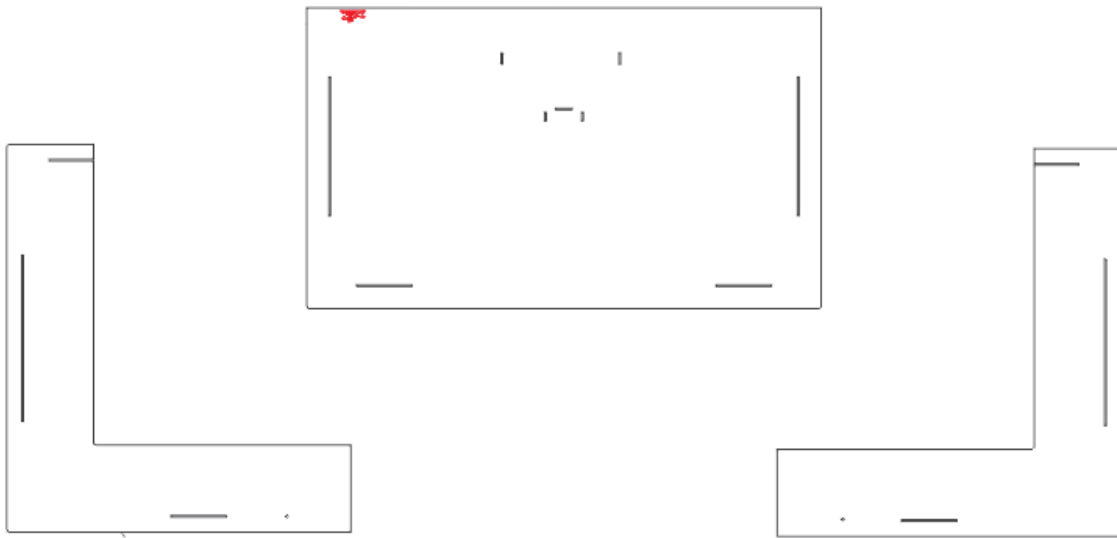

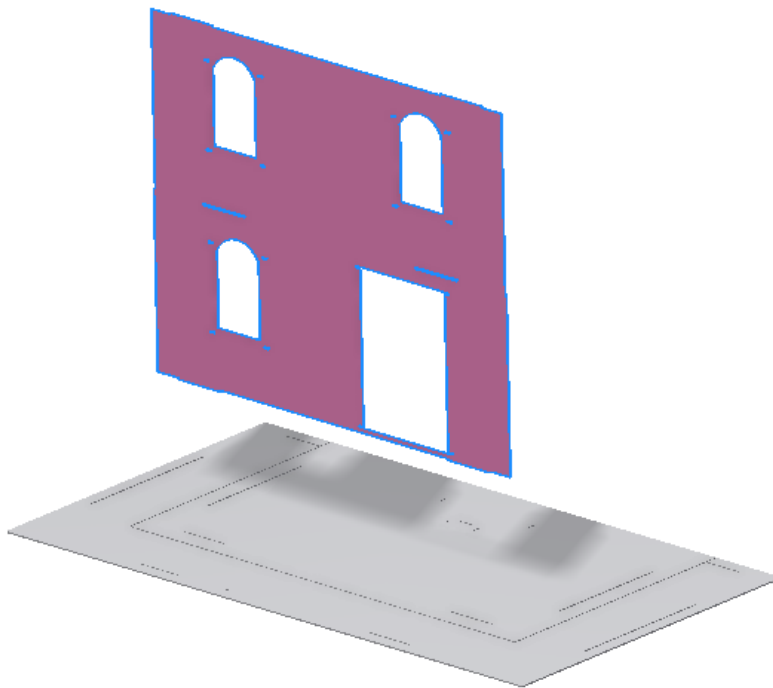
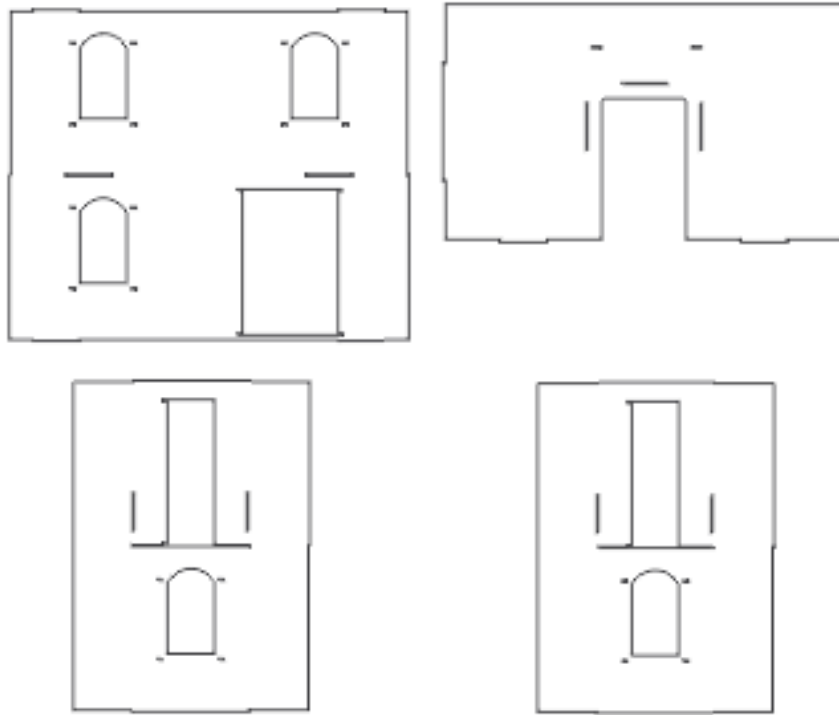

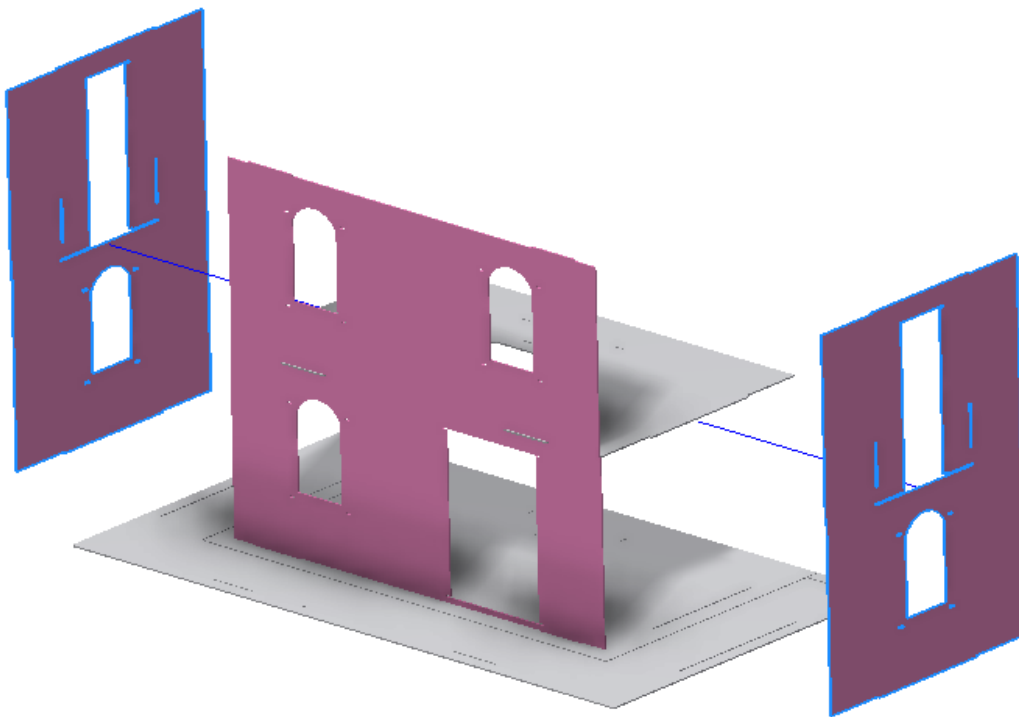
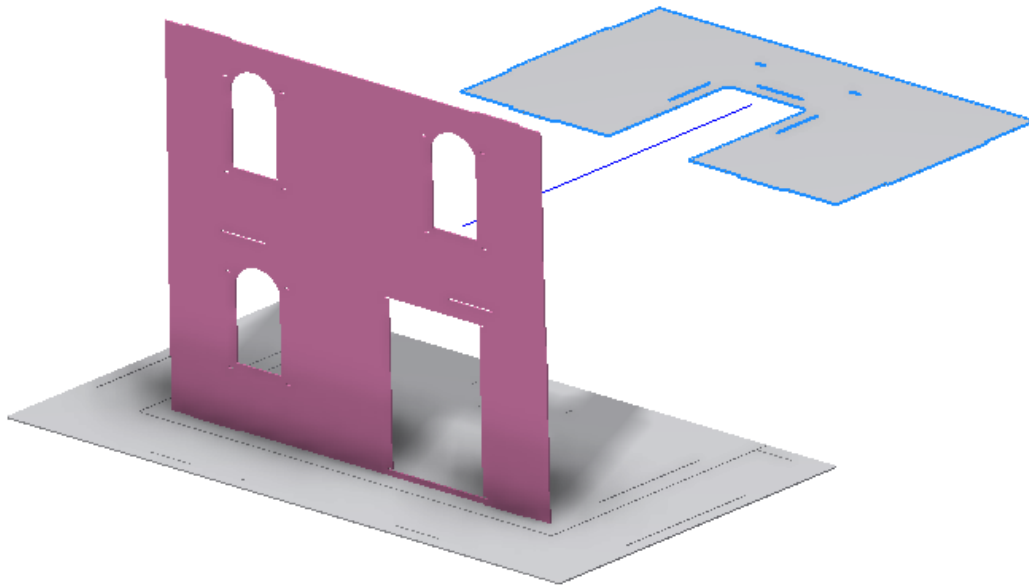

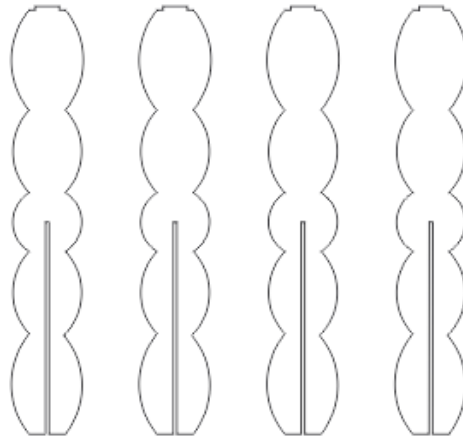
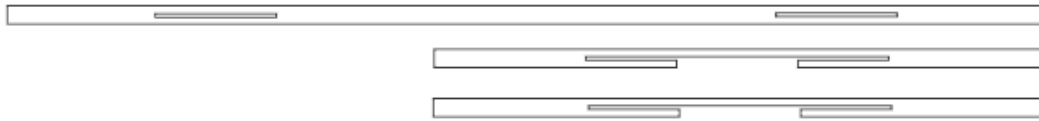

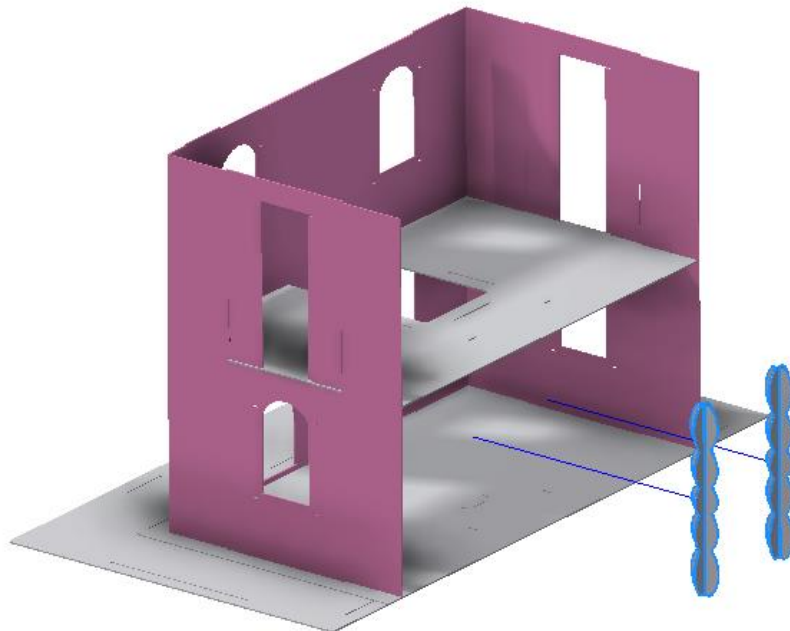



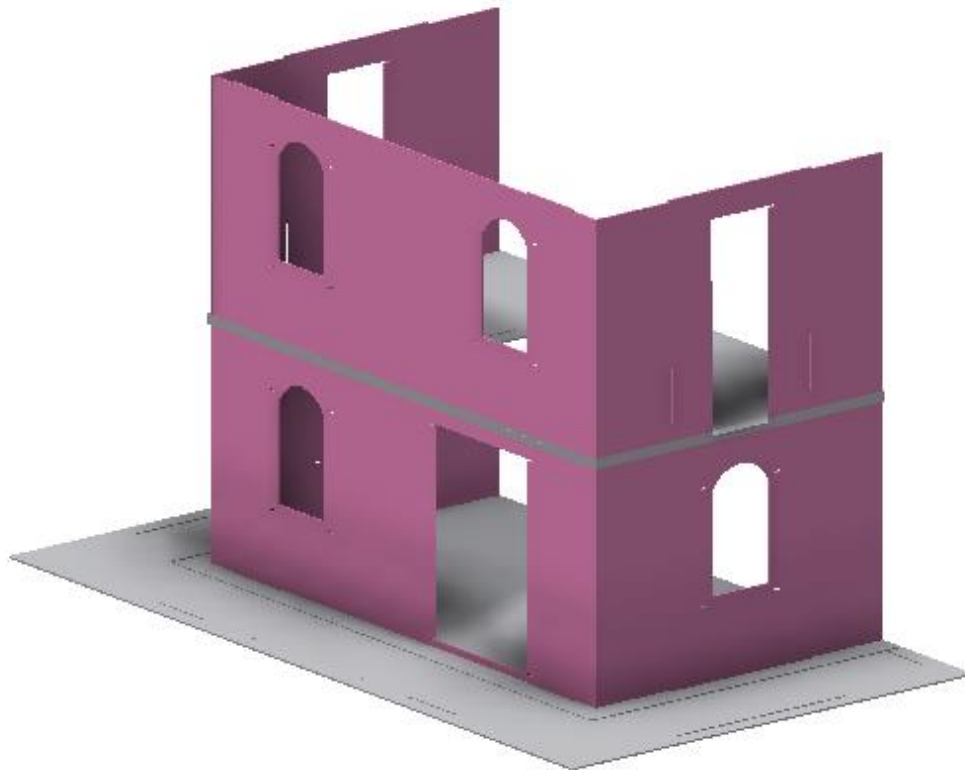
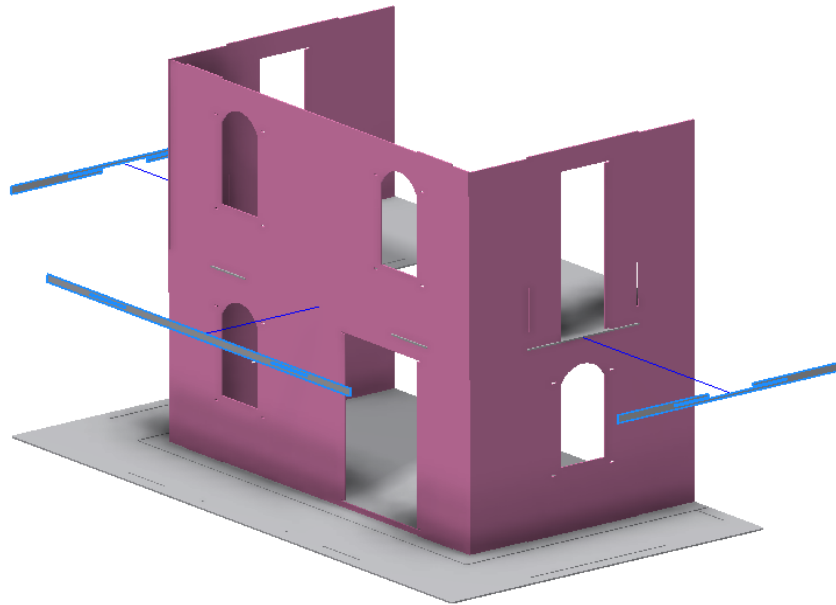

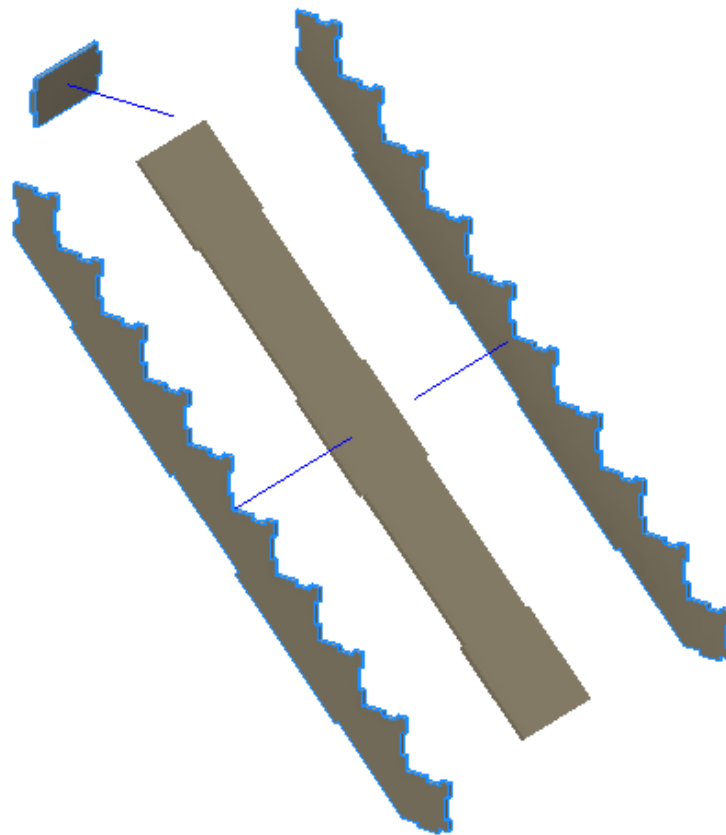
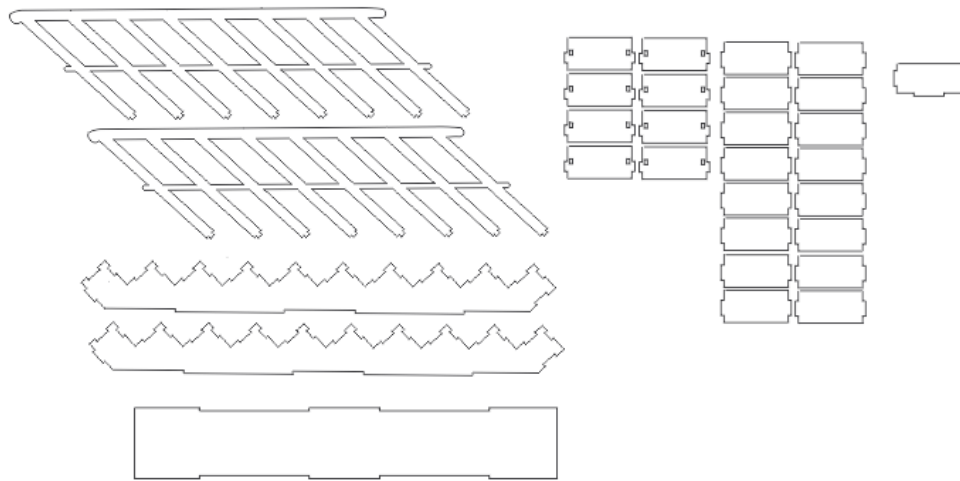

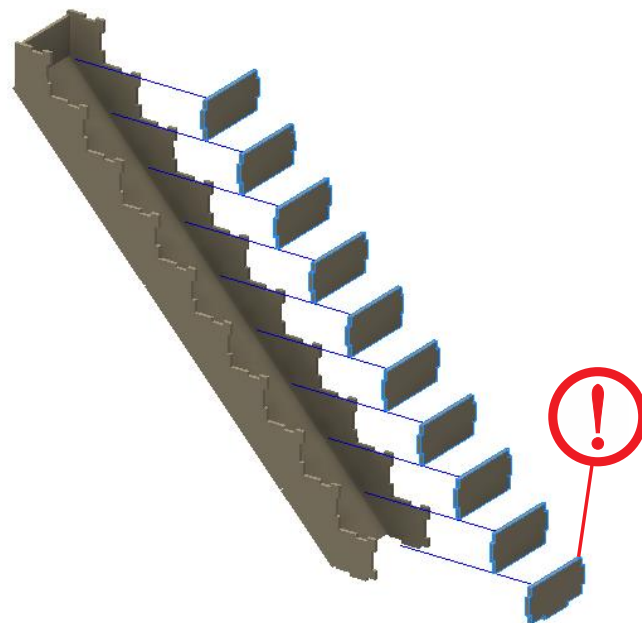
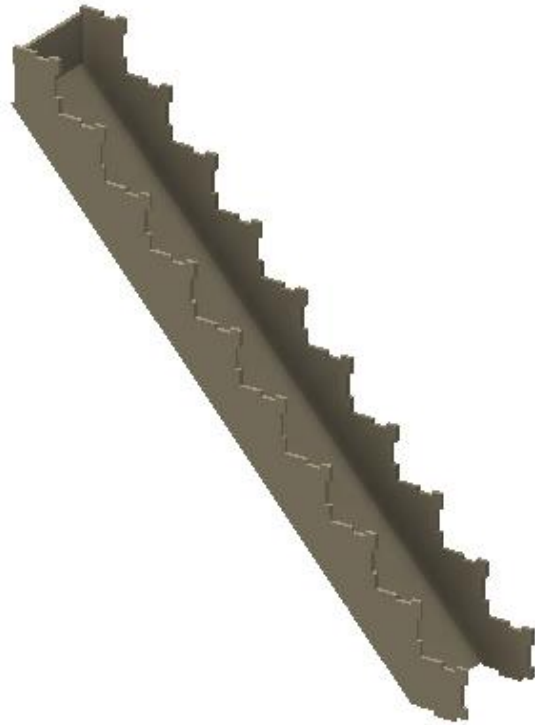

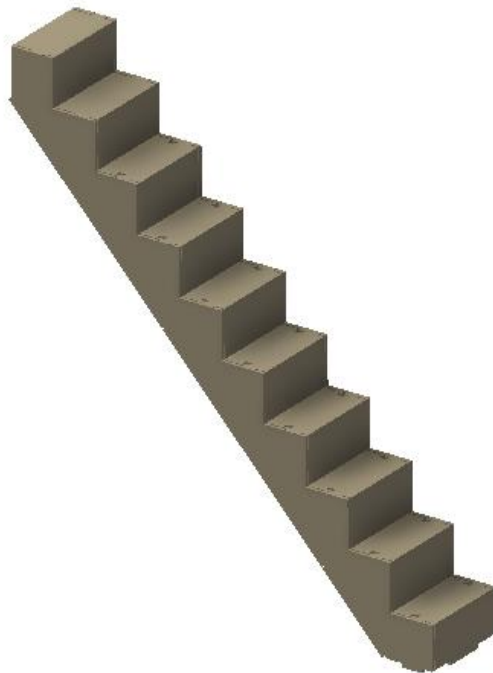
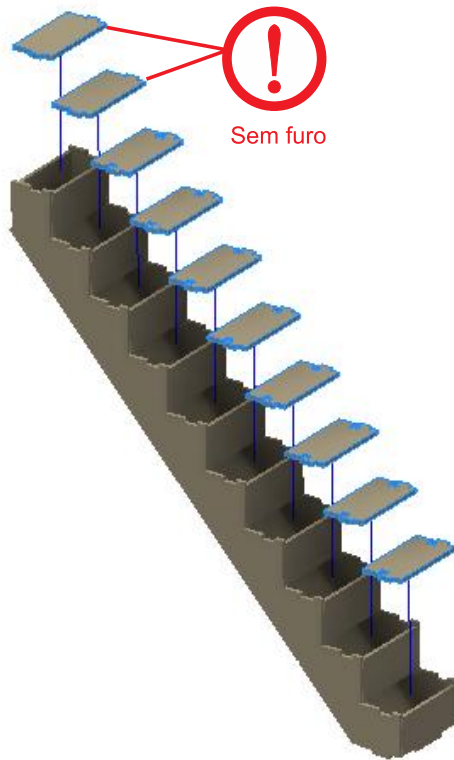

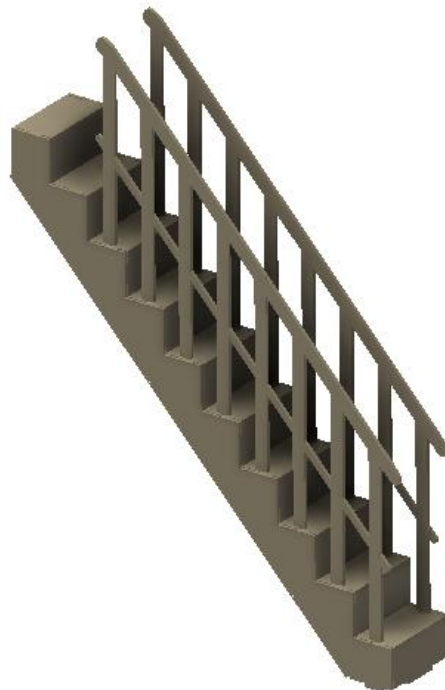
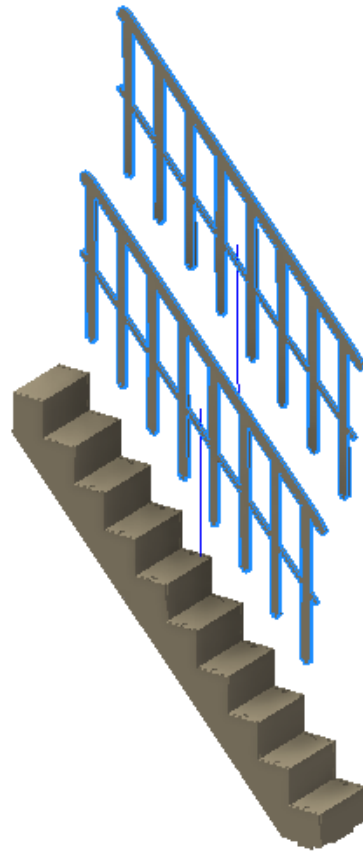

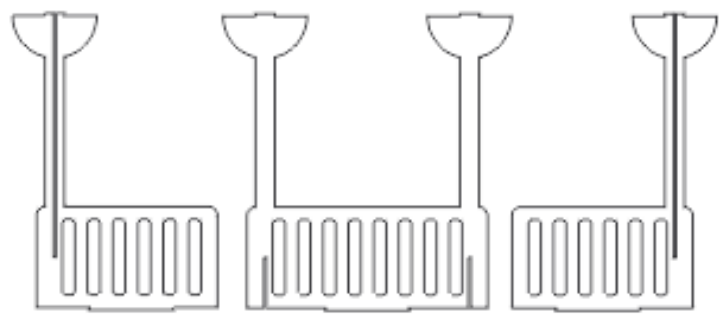
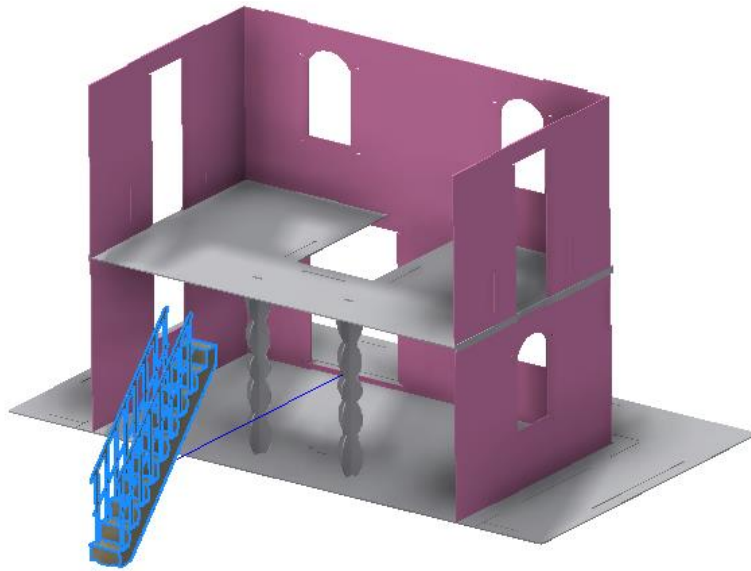

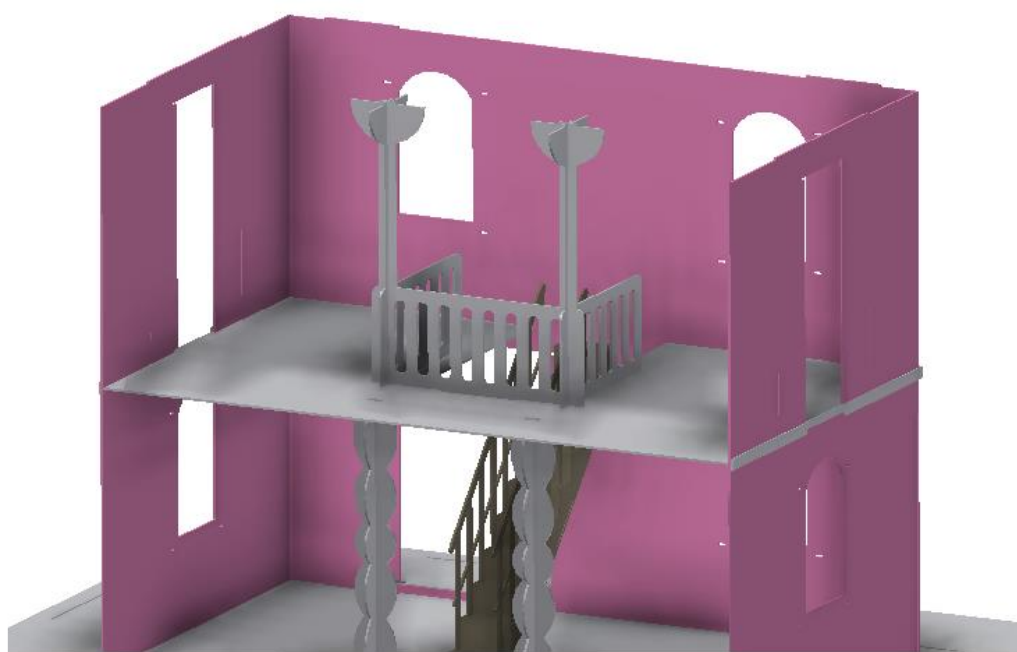
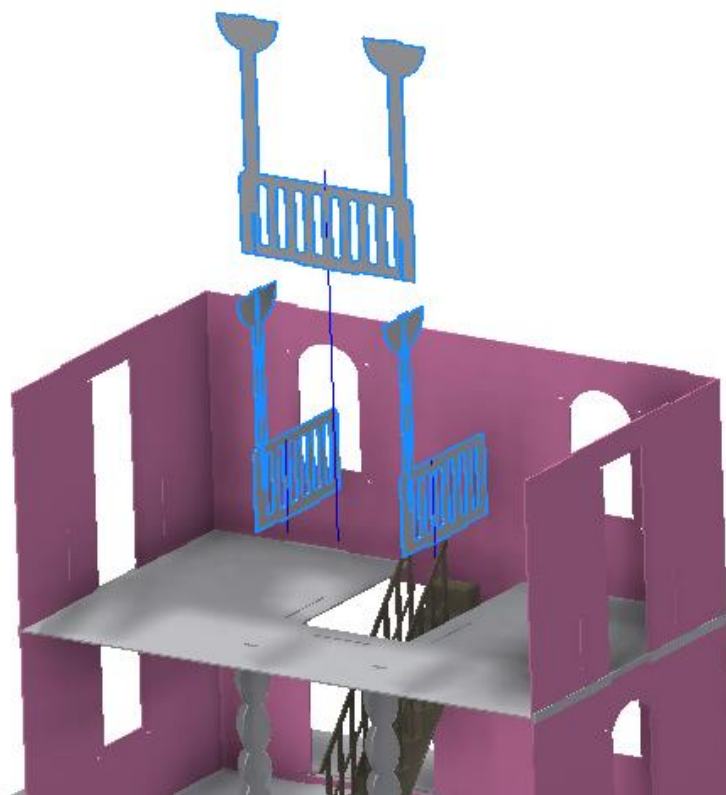

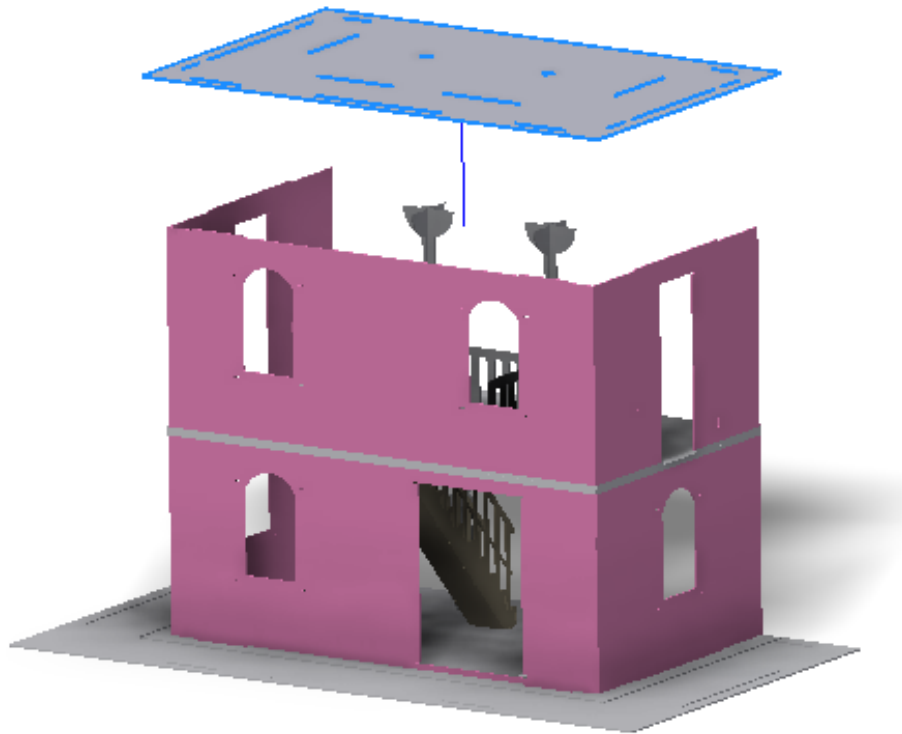



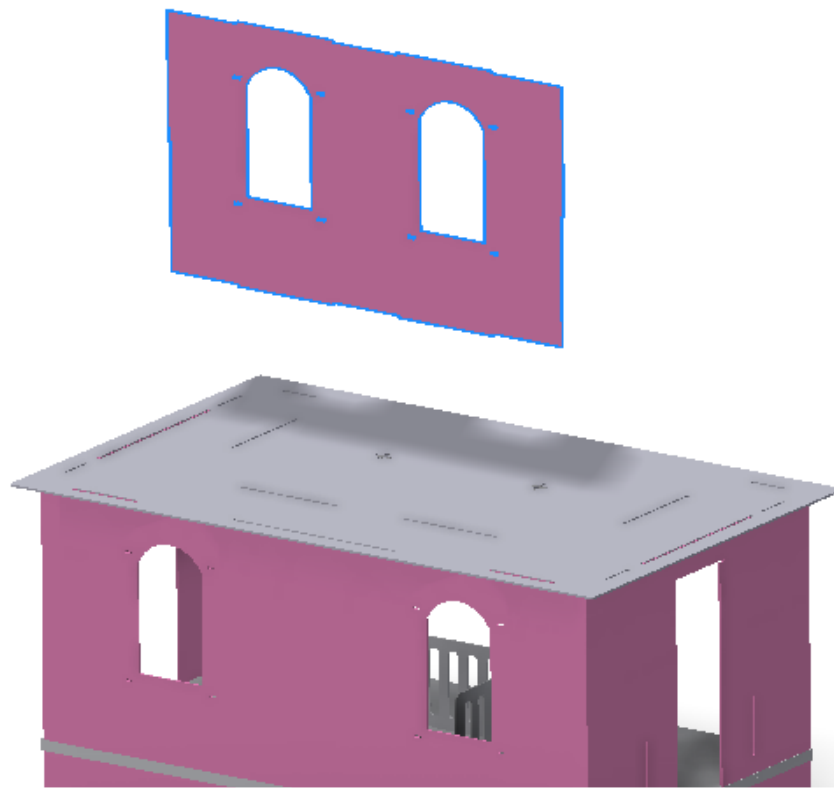
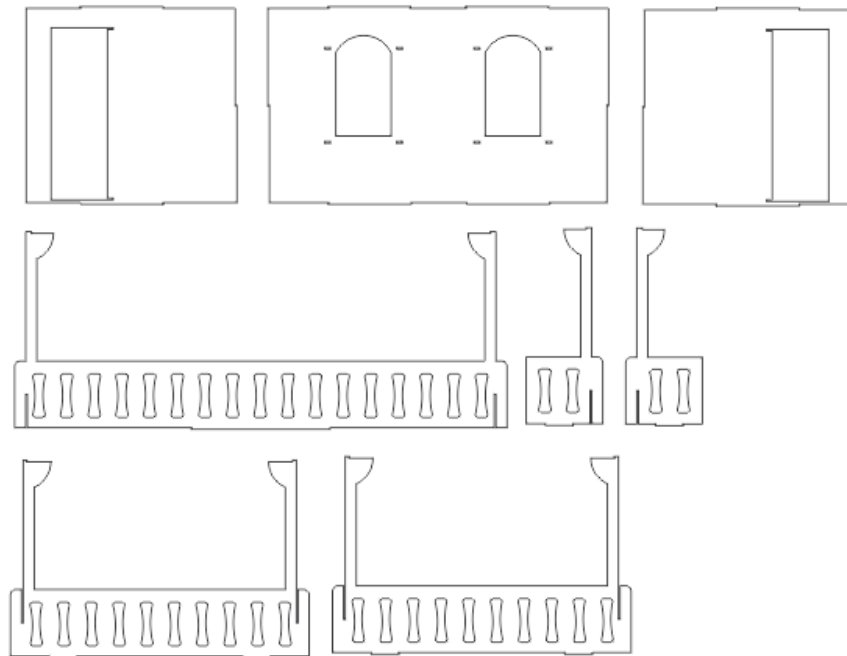

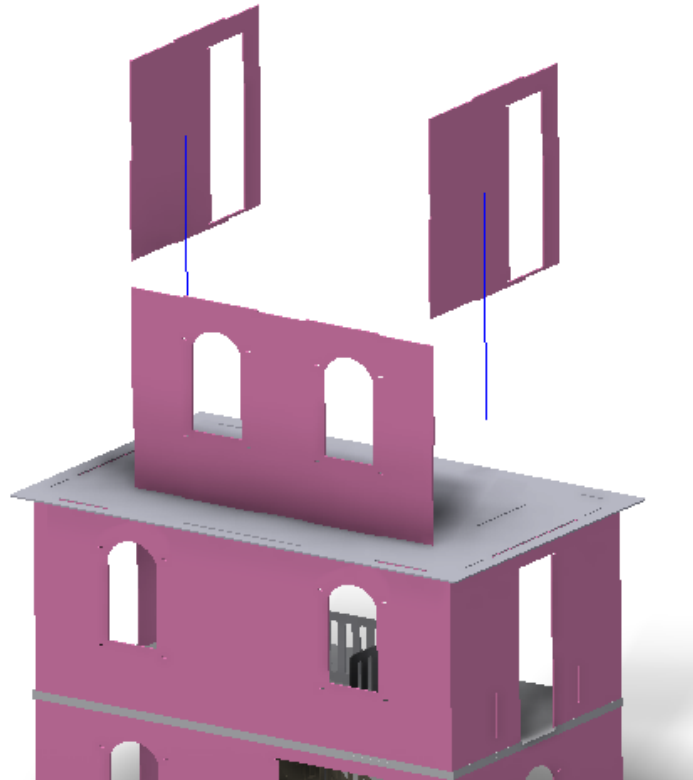

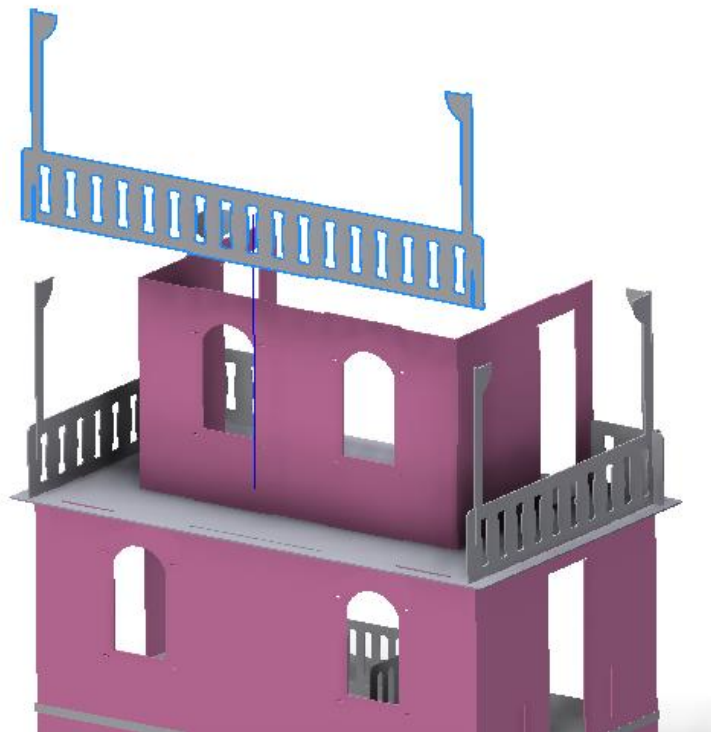
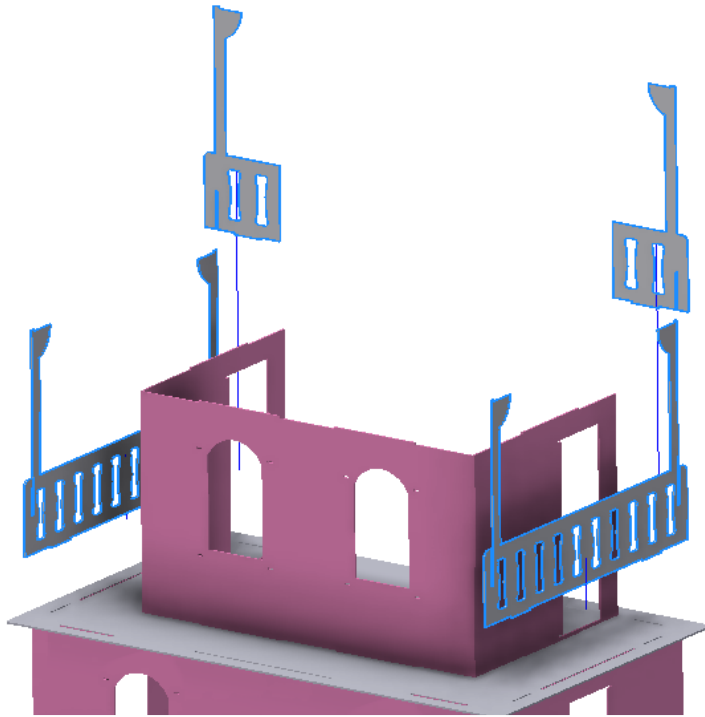

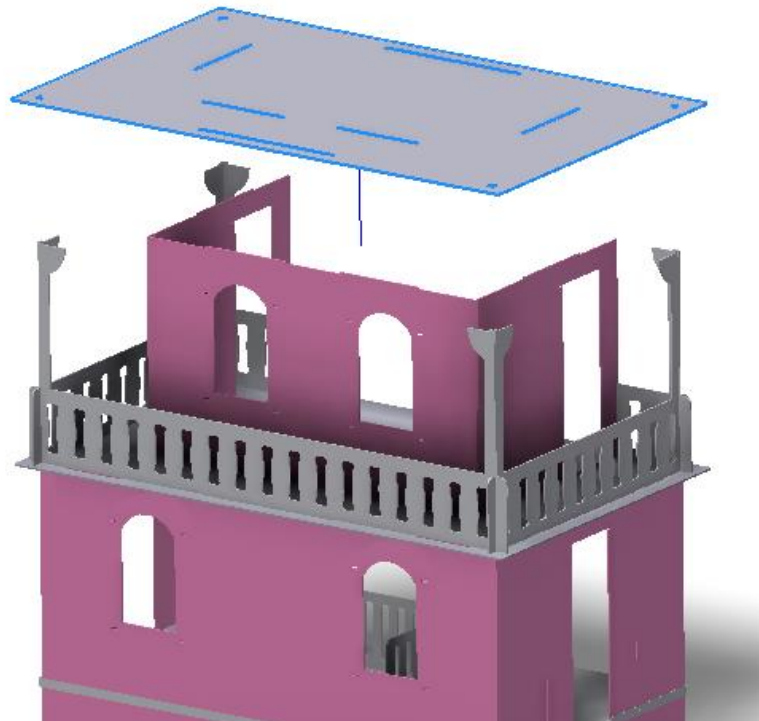
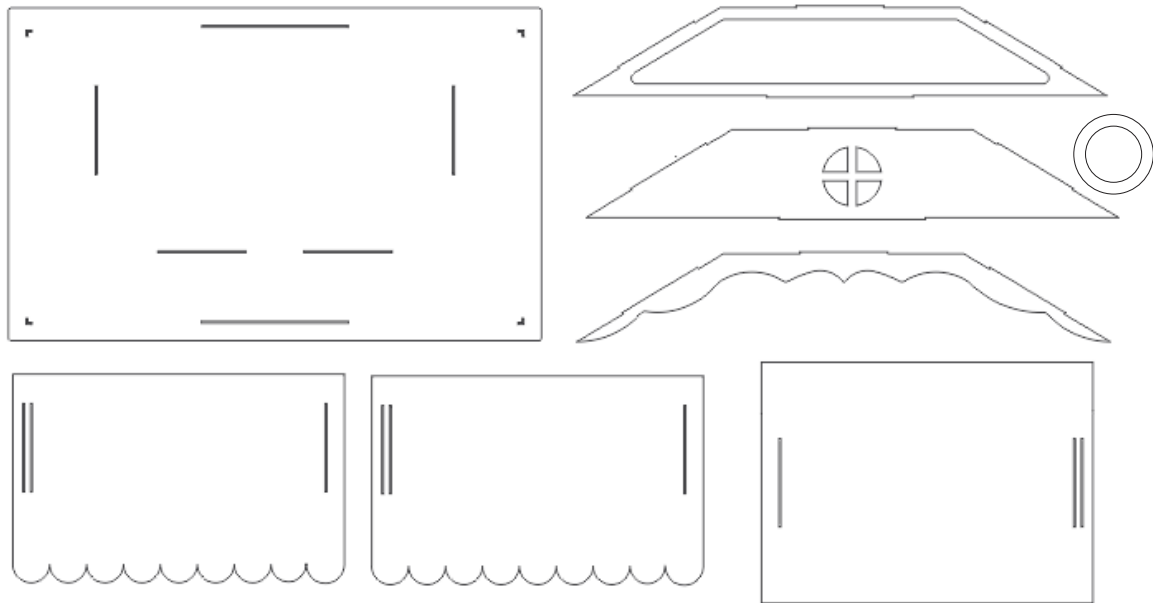

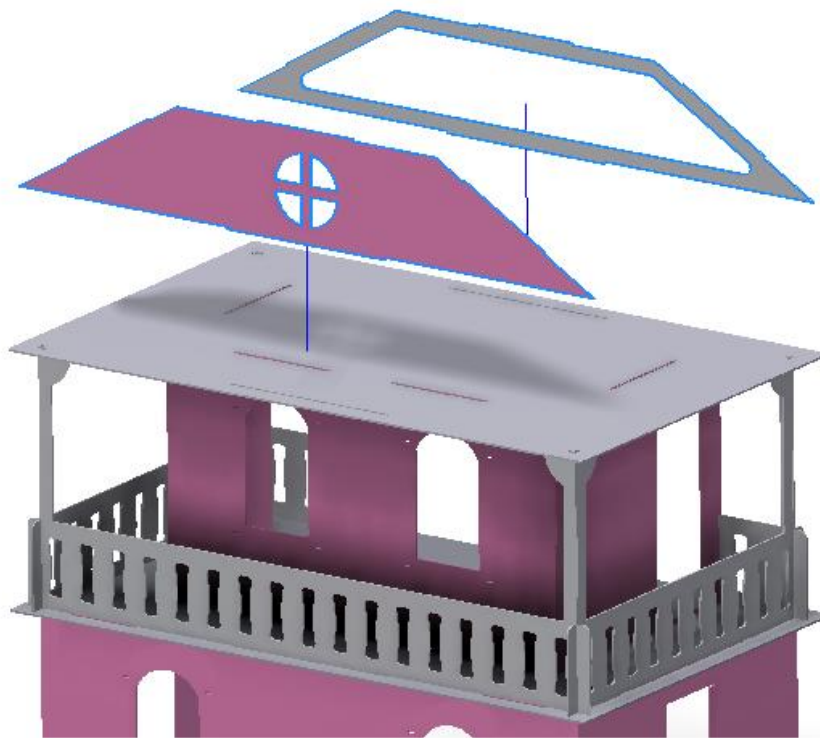

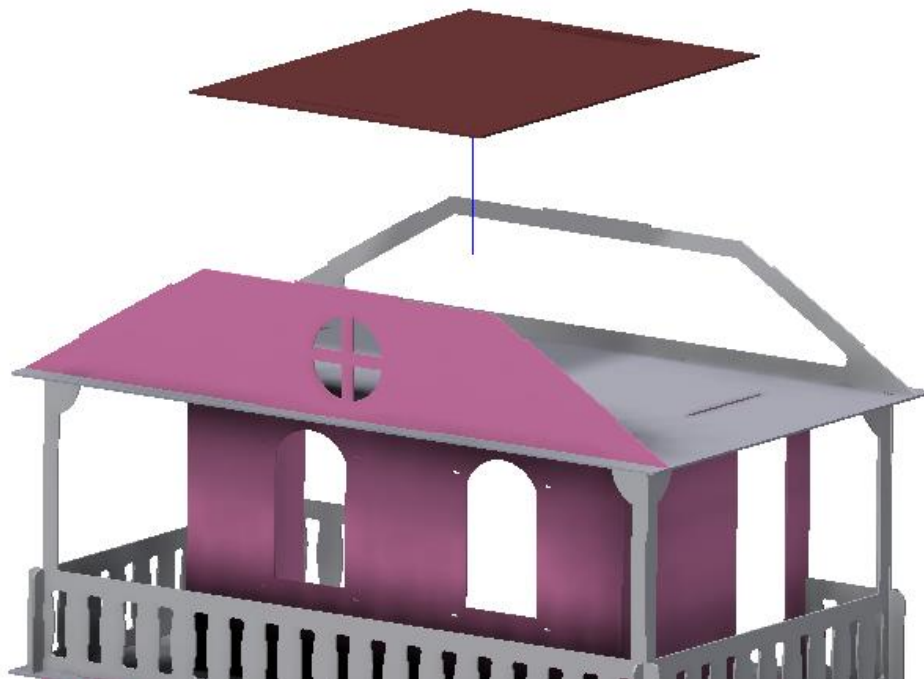

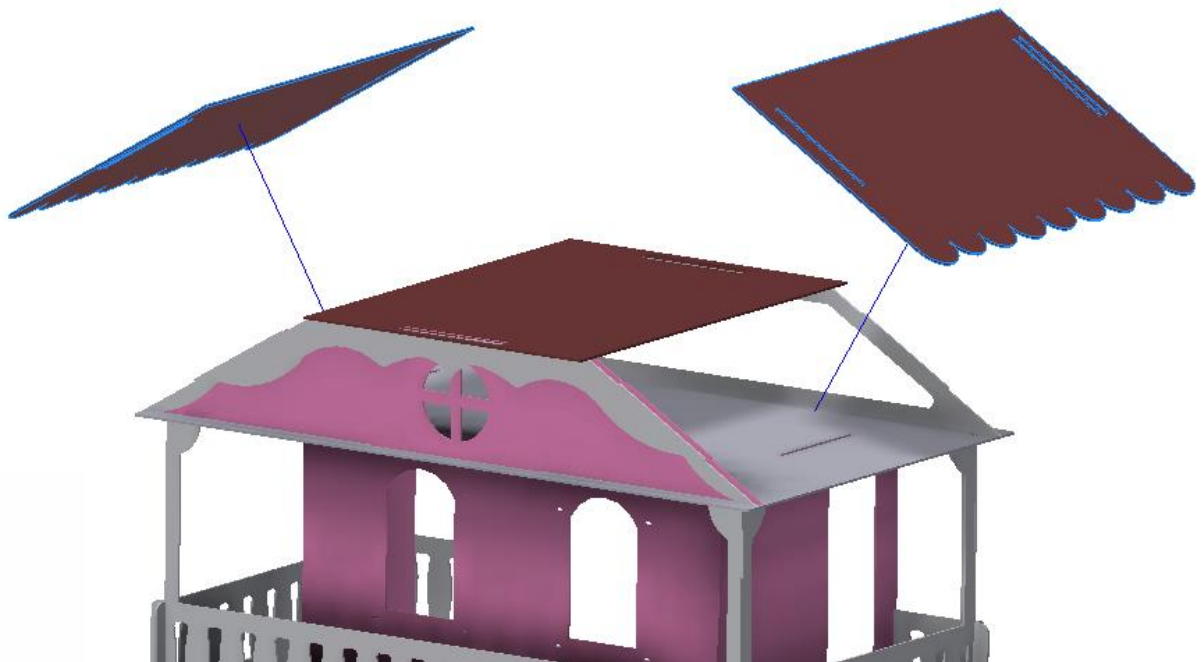
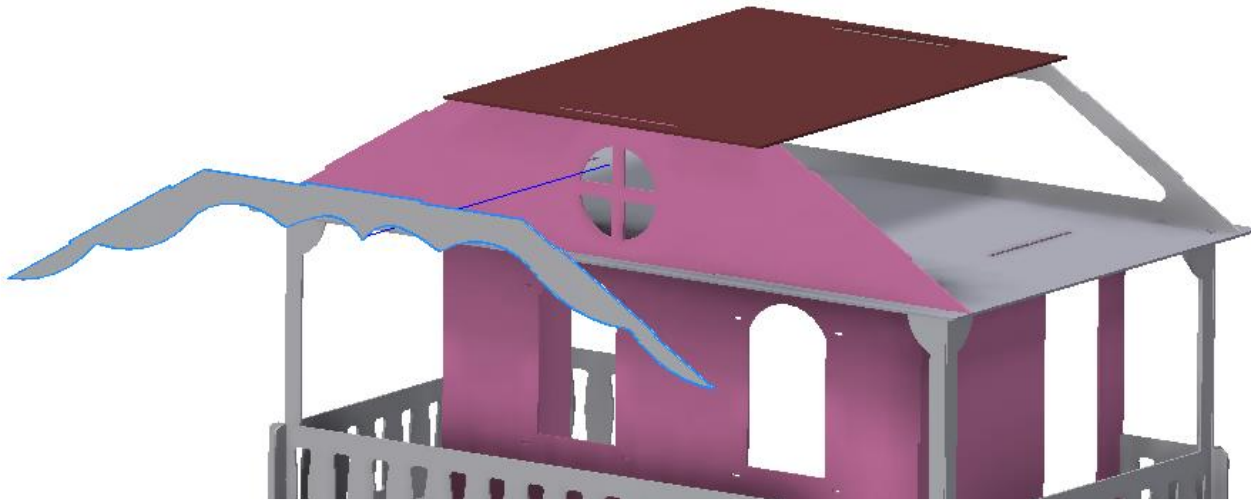



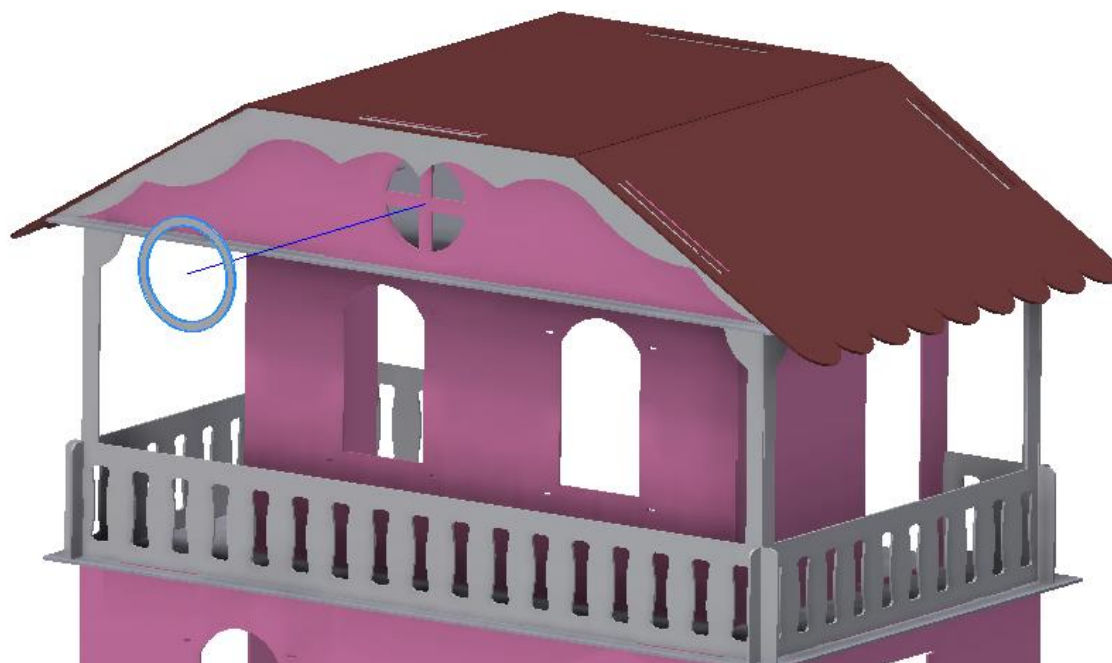



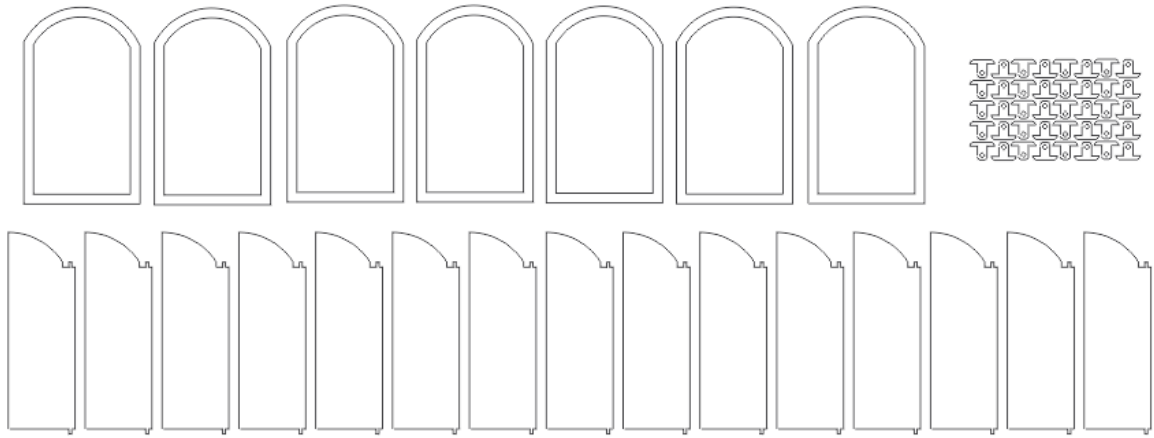

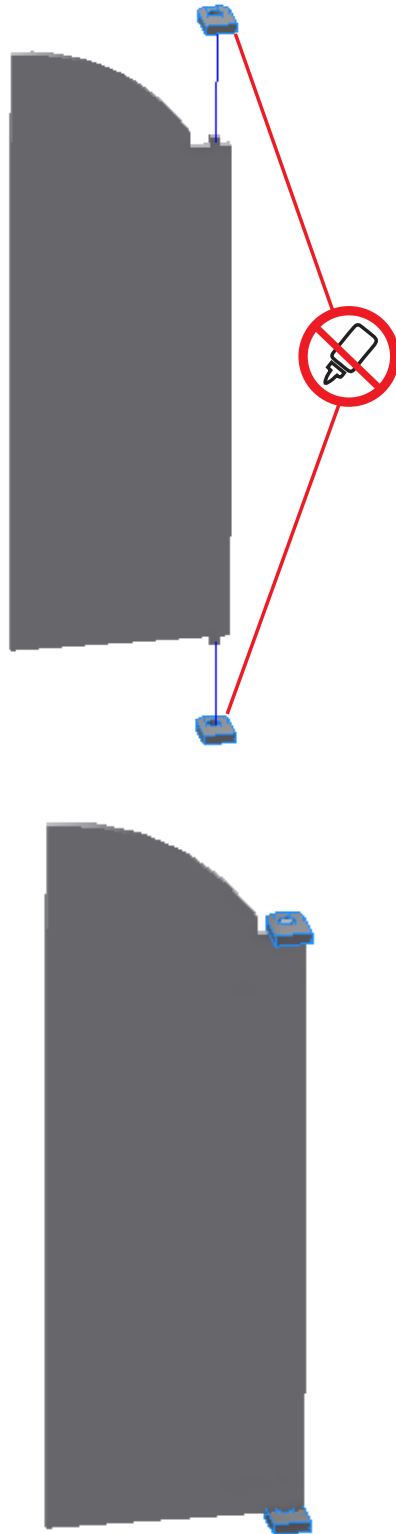

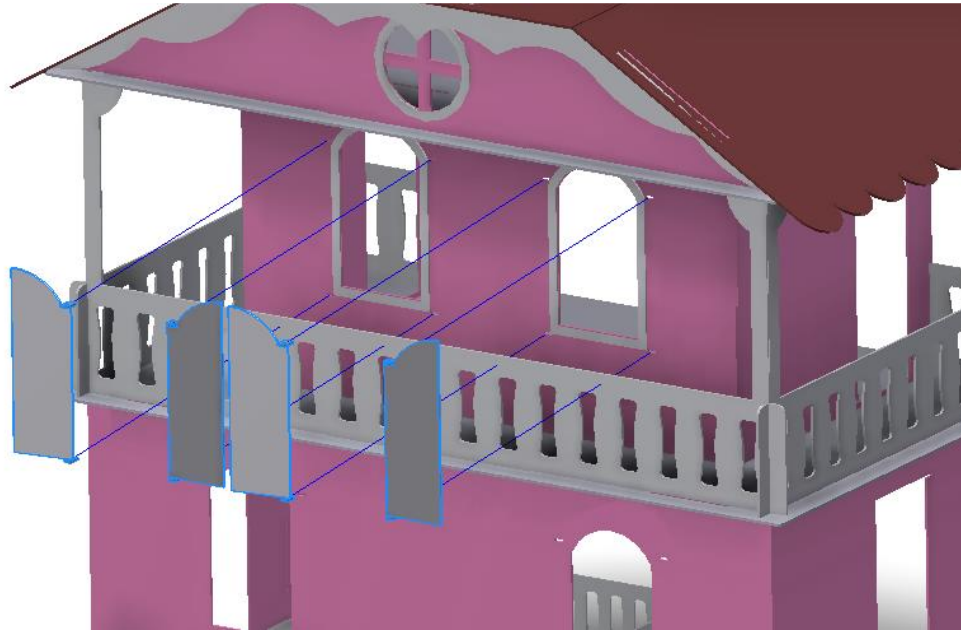





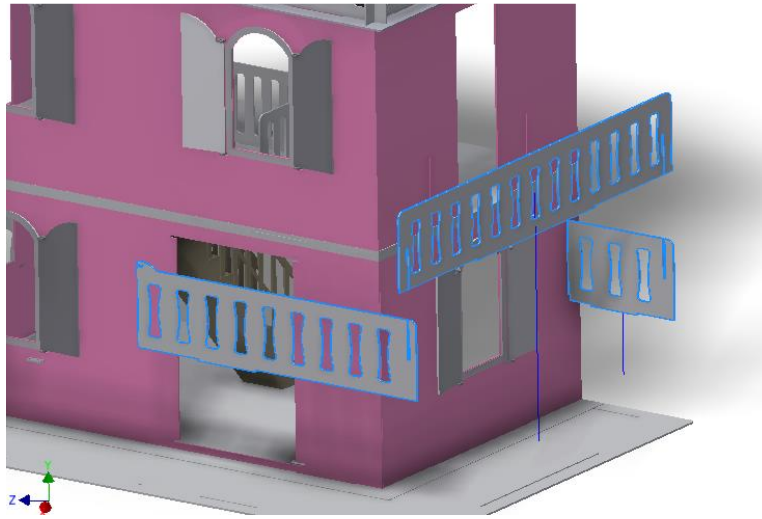
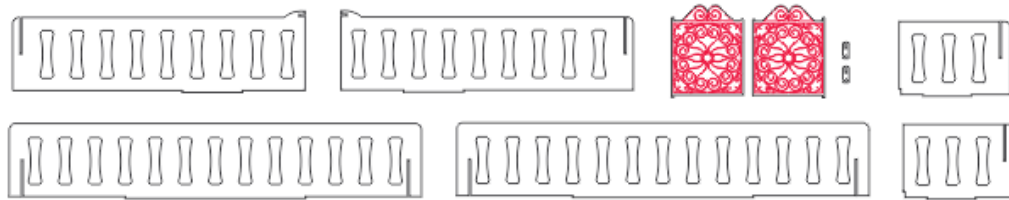

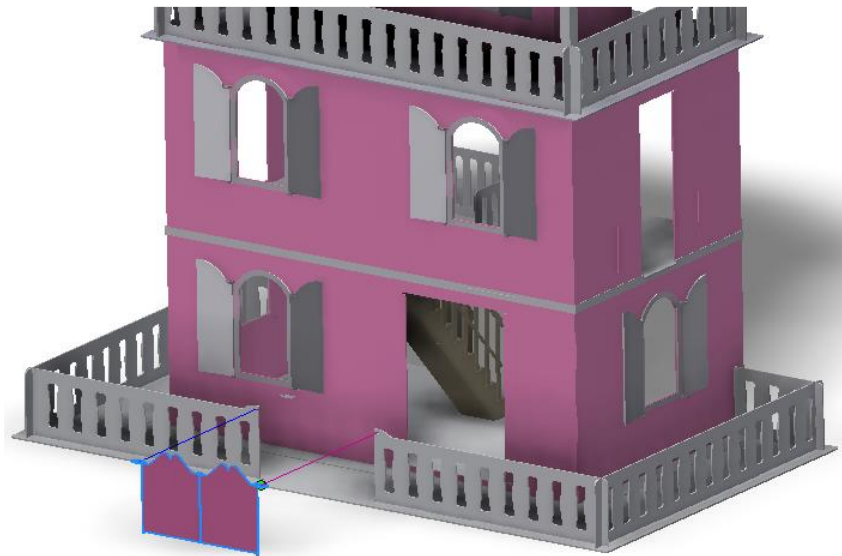
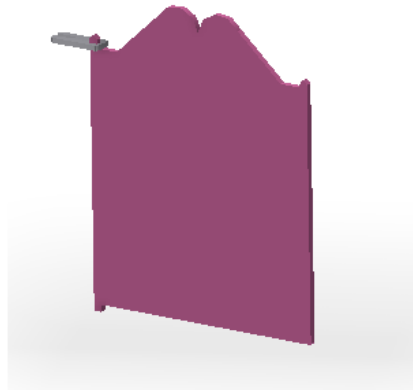
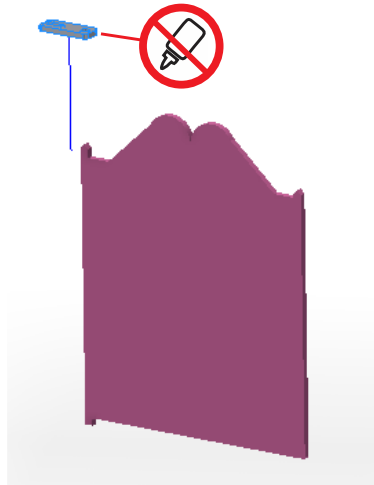



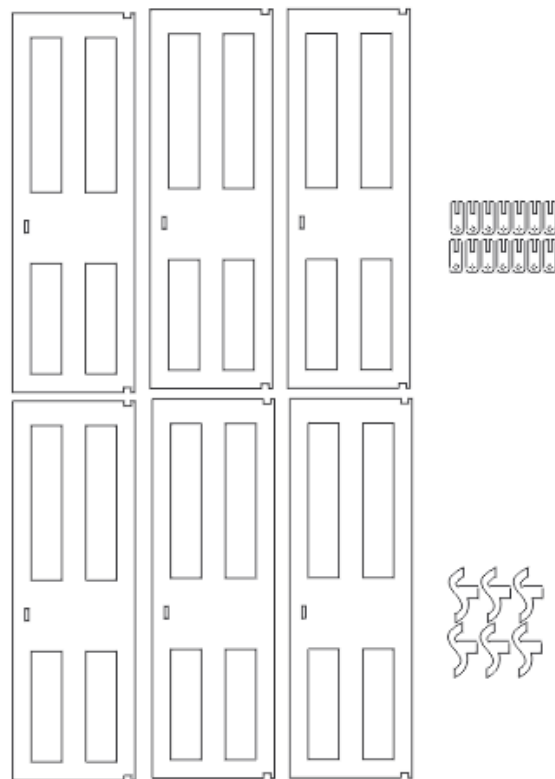



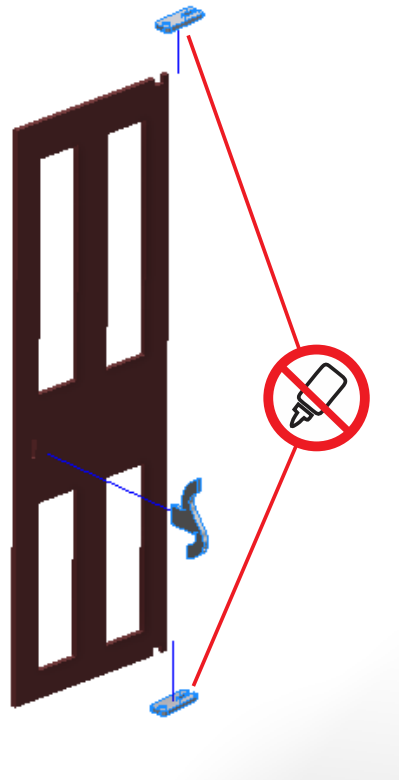



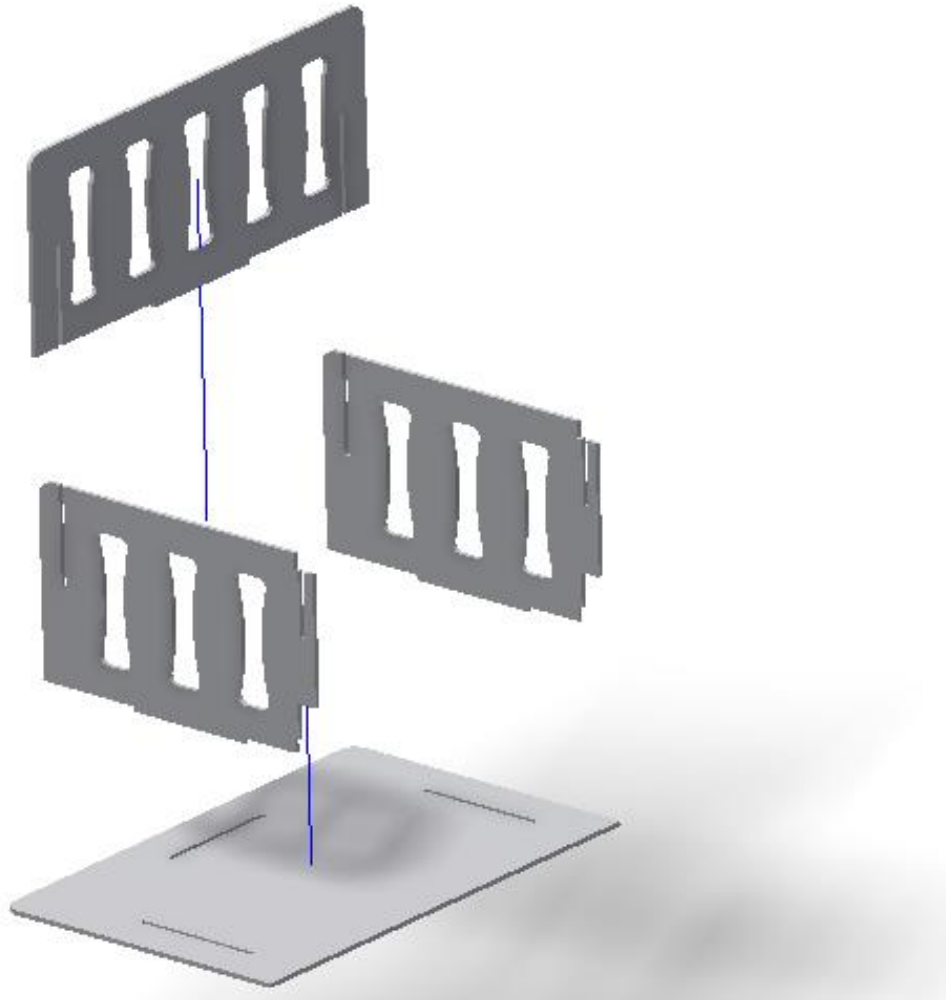
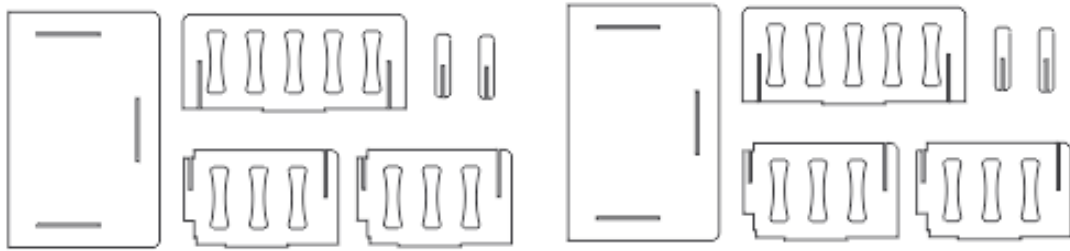



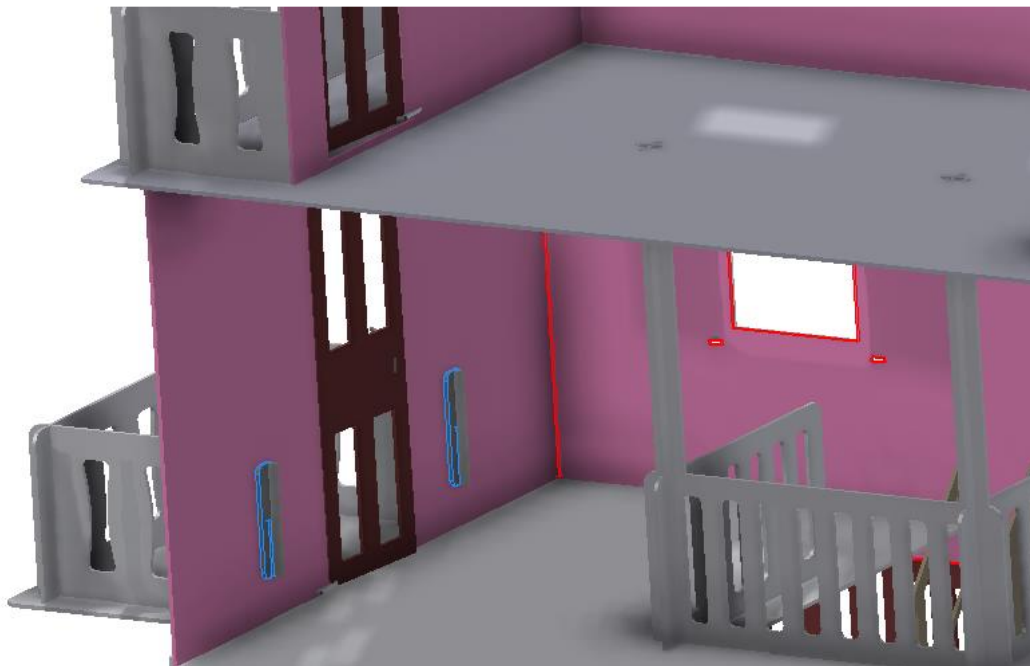
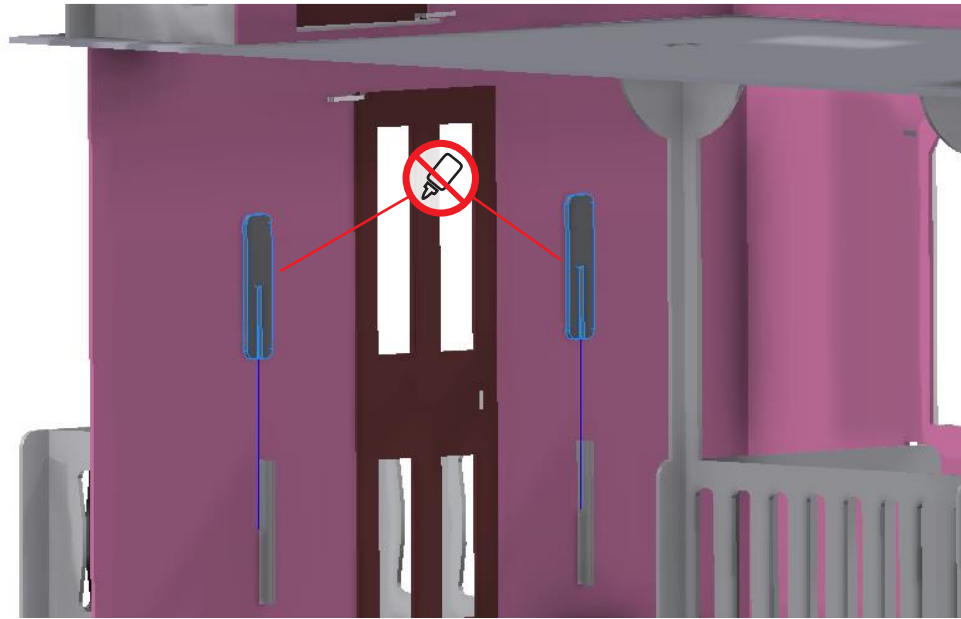



**Fim**